



GEM-YEAR INDUSTRIAL CO., LTD.

ADD: No.8 Gem-Year Road, E.D.Z., Jiashan Zhejiang Province, China P.C:314100
TEL: (86-573)84185001(48 Lines)
FAX: (86-573)84184488 84184567 84184888
Http://www.GEM-YEAR.com
E-mail: admin@gem-year.net



CYI®
2017 JUL.

www.GEM-YEAR.com

2017.07



CYI - Create Your Ideas

1980

Jinn-Her Enterprise Co., Ltd. was established in Kaoshung, Taiwan.

1988.8

Chin-Well Holdings Berhad was established in Malaysia.

1995.11

Gem-Year Industrial Co., Ltd. was established under the approval of the Authority of Zhejiang Government with a total investment of USD 30 million and registered capital of USD 15 million.

1999.12

Additional capitals raised with the authorization of MOFTEC P.R.C. led to the total investment, and the total registered capital to USD 106 million, and USD 62 million, respectively.

2002.9

Jinn-Well Auto Parts(Zhejiang) Co., Ltd. Was established, in Zhejiang, China.

2003.6

Gem-Year Auto Parts(Guangzhou) Co., Ltd. Was established, in Zhejiang, China.

2003.10

Gem-Year Industrial Co., Ltd. Was established, in Zhejiang, China.

2004.1

"CYI" was recognized as famous brand in Zhejiang.

2004.3

"GEM-YEAR" was recognized as a famous trade name in Zhejiang.

2004.5

Gem-Kai International Trading(Shanghai) Co., Ltd. Was established, in Shanghai, China.

2005.12

Gem-Duo Co., Ltd. was established, in Shanghai China.

2006.4

Won bids for the first high speed railway fastening systems project of USD 100 million.

2007.1

GEM-YEAR' s IPO at Shanghai Stock Exchange.

2008.1

"GEM-YAER" as recognized as a famous trademark, in China.

2009.10

First high speed railway fastening systems manufacturer to pass the technical review on passenger-only railway fastening systems conducted by the Chinese Ministry of Railways.

2010.8

GEM-YEAR Logistics Co., Ltd. (Quanzhou) was established, in Fujian, China.

2011.4

GEM-YEAR Logistics Co., Ltd. (Shenyang) was established, in Liaoning, China.

2012.1

GEM-YEAR Logistics Co., Ltd. was established, in Zhejiang, China.

2012.7

"Top 500 China Machinery" for 10 straight years.

2012.8

GEM-YEAR Hardware Distribution Co., Ltd. (Hubei) was establish, in Zhejiang, China.

2012.11

"Industry Leading Company in China" for 3 straight years.



About CYI®

CYI is a professional hand tool brand, more importantly it is also a service oriented brand. Offering quality products gives a brand a brand, but effectively servicing its users makes a brand "the brand!" We address three major concerns of professional hand tool users when designing our product and service offerings.

First, CYI offers both comprehensive hand tool sets and individual open stock to fulfill various needs of different professional industrial users in automotive repair, construction, maintenance, and manufacturing sectors.

Secondly, immediate availability is also another key issue plagued by brand' s inconsistency in supply chain. CYI hand tools are produced by a mega-size hardware manufacturer who is capable over 2 billion individual tool pieces annually for the brand only, and such dedication ensures a uninterrupted supply chain from the factory to the end users.

Last, but not the least, CYI also addresses users' concerns on quality by not only meeting or exceeding both the ANSI and DIN standards, but also backing our products with a LIFETIME WARRANTY. Users can feel our confidence in the durability of our tools, and even if it breaks, they know that they' re covered by a hassle free warranty.

About Our Manufacturer...

CYI is a brand crafted by Gem-Year Industrial Co., Ltd., a mega-size hardware manufacturer founded in 1995, and is a publicly listed company (Trade code: 601002) at the Shanghai Stock Exchange with annual turnover of US\$500 million.

As a 10-time Top 500 Chinese Machinery company, Gem-Year has been the global leader in multiple industries where its hardware products thrive. In addition to its hand tool line, both fasteners and railway fastening systems are the other product lines that give it its global leading positions.

Gem-Year is the largest fasteners producer in the global market with capacity of 400,000 metric tons. Its dedication in vertical integration also makes it the only manufacturer in the world that is capable of producing the entire railway fastening systems in house with capacity of 10 million sets annually, which are sufficient to support up to 1,500 kilometers (nearly 1,000 miles) of railways.

In addition, its leading positions in various industries have been further reinforced through its 900,000 sq-m (10,000,000 sq-ft) facility which is certified by ISO 9001, ISO/TS 16949, ISO/IEC 17025, ISO 14001, and QC 080000.

Choose CYI as your partner to help you "C" reate "Y" our "I" ndustry!





H01009 1500012
150PC. 1/4" & 3/8" & 1/2" DR. SOCKET WRENCH SET (METRIC & S.A.E.) (1set/ctn)



- 10-1/4"Dr. 6pt. Metric Sockets 4,5,6,7,8,9,10,11,12,13mm
- 10-1/4"Dr. 6pt. S.A.E. Sockets 5/32", 3/16", 7/32", 1/4", 9/32", 5/16", 11/32", 3/8", 7/16", 1/2"
- 6-1/4"Dr. 6pt. Metric Deep Sockets 4,5,6,7,8,9mm
- 11-3/8"Dr. 6pt. Metric Sockets 9,10,11,12,13,14,15,16,17,18,19mm
- 9-3/8"Dr. 6pt. S.A.E. Sockets 3/8", 7/16", 1/2", 9/16", 5/8", 11/16", 3/4", 13/16", 7/8"
- 6-3/8"Dr. 6pt. Metric Deep Sockets 10,11,12,13,14,15mm
- 2-3/8"Dr. Spark Plug Socket 16,21mm
- 22-3/8"DR. Bits Sockets Slotted 4,5,5,6.5mmPhillips #1,#2,#3Pozidriv #1,#2,#3
- Torx 20,30,40,45,50,55,60(Tamper Proof) Hex 3,4,5,6,8,10mm
- 8-3/8"Dr. 6pt. E-Torx Sockets E8,E10,E11,E12,E14,E16,E18,E20
- 4-1/2"Dr. 6pt. Metric Impact Sockets 17,19,21,23mm
- 7-1/2"Dr. 12pt. Metric Sockets 20,21,22,24,27,30,32mm
- 4-1/2"Dr. 12pt. S.A.E. Sockets 15/16", 1", 1-1/16", 1-1/4"
- 6-1/2"Dr. 6pt. Metric Deep Sockets 10,12,13,14,17,19mm
- 45-Accessories
- 1/4", 3/8", 1/2"Dr. Quick-Release Ratchets
- 1/4"Dr. Bit Coupler
- 1/4"Dr. Spinner Handle
- 1/4"Dr. Wobble Extension Bars 4"
- 3/8"Dr. Wobble Extension Bars 3", 6"
- 1/2"Dr. Wobble Extension Bars 5"
- 1/2"Dr. Locking Extension Bars 10"
- 1/4", 3/8", 1/2"Dr. Universal Joints
- 1/4"Shank Torx Bits (Tamper Proof) T-10,T-15,T-20,T-25,T-27,T-30,T-40 Hex Key Metric Set (10-)
- 12-Combination Wrenches 8,9,10,11,12,13,14,15,16,17,18,19mm
- Double Box Ratcheting Wrenches 8x10,12x13,17x19mm

H01008 1500011
120PC. 1/4" & 3/8" & 1/2" DR. SOCKET WRENCH SET (METRIC & S.A.E.) (2set/ctn)



- 10-1/4"Dr. 6pt. Metric Sockets 4,5,6,7,8,9,10,11,12,13mm
- 10-1/4"Dr. 6pt. S.A.E. Sockets 5/32", 3/16", 7/32", 1/4", 9/32", 5/16", 11/32", 3/8", 7/16", 1/2"
- 4-1/4"Dr. Metric Deep Sockets 8,9,10,12mm
- 7-1/4"Shank 25L Tamper-Proof Torx Bits T-10,T-15,T-20,T-25,T-27,T-30,T-40
- 11-3/8"Dr. 6pt. Metric Sockets 9,10,11,12,13,14,15,16,17,18,19mm
- 9-3/8"Dr. 6pt. S.A.E. Sockets 3/8", 7/16", 1/2", 9/16", 5/8", 11/16", 3/4", 13/16", 7/8"
- 4-3/8"Dr. Metric Deep Sockets 13,14,15,17mm
- 2-3/8"Dr. Spark Plug Sockets 16,21mm
- 17-3/8"Dr. Bit Sockets
- Slotted 4,5,5mmPhillips #1,#2Pozidriv #1,#2Torx 20,30,40
- Tamper Proof Torx 45,50,55,60Hex 3,4,5,6mm
- 8-3/8"Dr. E-Torx Sockets E8, E10, E11, E12, E14, E16, E18, E20
- 7-1/2"Dr. 6pt. Metric Sockets 20,21,22,24,27,30,32mm
- 4-1/2"Dr. 6pt. S.A.E. Sockets 5/16", 1", 1-1/16", 1-1/4"
- 4-1/2"Dr. 6pt. Metric Impact Sockets 17,19,21,23mm
- 23-Accessories
- 1/4", 3/8", 1/2"Dr. Quick-Release Ratchets
- 1/4"Dr. Spinner Handle
- 1/4"Dr. Wobble Extension Bars 2"
- 3/8"Dr. Wobble Extension Bars 3", 6"
- 1/2"Dr. Wobble Extension Bars 5", 10"
- 1/4", 3/8", 1/2"Dr. Universal Joints
- 1/4"Shank x 1/4"Dr. Bit Coupler
- Combination Wrenches 8,9,10,11,12,13,14,17,18,19mm

H01007 1500010
86PC. 1/4" & 1/2" DR. SOCKET SET (METRIC) (3set/ctn)



- 14-1/4"Dr. 6pt. Metric Sockets 3,5,4,4,5,5,5,5,6,7,8,9,10,11,12,13,14mm
- 8-1/4"Dr. 6pt. Metric Deep Sockets 6,7,8,9,10,11,12,13mm
- 17-1/4"Dr. Bit Sockets
- Slotted 4.0,5,5,6,5mm Phillips #1,#2 Pozidriv #1,#2 Torx 8,10,15,20,25,30 Hex 3,4,5,6mm
- 2-1/2"Dr. Spark Plug Sockets 16,21mm
- 14-1/2"Dr. 6pt. Metric Sockets 10,13,15,16,17,18,19,20,21,22,24,27,30,32mm
- 4-1/2"Dr. 6pt. Metric Deep Sockets 14,15,17,19mm
- 15-5/16"Shank 30L Bits
- Slotted 8,10,12mm Phillips #3,#4 Pozidriv #3,#4
- Torx 40,45,50,55Hex 8,10,12,14mm
- 12-Accessories
- 1/4", 1/2"Dr. Quick-Release Ratchets
- 1/4"Dr. Sliding T-Bar
- 1/4"Dr. Wobble Extension Bars 2", 4"
- 1/2"Dr. Wobble Extension Bars 5", 10"
- 1/4", 1/2"Dr. Universal Joints
- 3/8"Fx1/2"M 3-Way Adapter
- 1/4"Dr. Spinner Handle
- 5/16"Shank x 1/2"Dr. Bit Coupler



H01014 1501482
58PC Machinery Repairing Set (2set/ctn)



- 14- 10MM 6pt. Socket (6,7,8,10,11,12,13,14,15,16,17,18MM)
- 10- Combination Wrench-Fool Polish (8,10,12,13,14,15,16,17,18,19MM)
- 1- Spud Ratcheting Wrench-17MM
- 1- 10MM Quick Release Ratchet
- 1- 10MM Universal Joint
- 9- Hex Key Wrench(1.5,2.2,2.5,3,4,5,6,8,10)
- 1- Adjustable Wrench
- 3- Screwdriver-Slot(6x38,3x75,5x100)
- 4- Screwdriver-Phillips(PH2x38,PH0x75,PH5x100)
- 1- Lineman's Pliers-8"
- 1- Long Nose Pliers-6"
- 5- Circlip Pliers Set
- 1- Measuring Tape-3MX16MM
- 1set 23- Feeler Gauge(0.02-1.00MM)
- 1- Stainless Ruler-150MM
- 1- Ball-Pein Hammer-16OZ Fiberglass Handle
- 1- Magnetic Pickup-380MM
- 1- Snap-off Utility Knife-8 Seg. 18X100MM Plastic Holder
- 1- Aluminum Flashlight-Two 7# Battery

Used for installing and repairing machine in manufacture and mine industry
Used for installing and dismanting new and old GB M15-M12 Bolt

H01006 1500009
65PC. 1/4" & 3/8" DR. SOCKET SET (METRIC & S.A.E.) (3set/ctn)



- 12-1/4"Dr. 6pt. Metric Sockets
- 4,4.5,5,5.5,6,7,8,9,10,11,12,13mm
- 10-1/4"Dr. 6pt. S.A.E. Sockets
- 5/32",3/16",7/32",1/4",9/32",5/16",11/32",3/8",7/16",1/2"
- 18-1/4"Shank 25L Bits
- Slotted 4,5,5.5,6,5mm
- Phillips PH1,PH2,PH3
- Torx 10,15,20,25,30,40
- Hex 3,4,5,6,7,8mm
- 10-3/8"Dr. 6pt. Metric Sockets
- 10,11,12,13,14,15,16,17,18,19mm
- 8-3/8"Dr. 6pt. S.A.E. Sockets
- 3/8",7/16",1/2",9/16",5/8",11/16",3/4",13/16"
- 1-3/8"Dr. Metric Spark Plug Socket 16mm
- 6-Accessories
- 3/8"Dr. Quick-Release Ratchet
- 3/8"Dr. Wobble Extension Bars 3"
- 3/8"Dr. Universal Joint
- 1/4"Shank x 1/4"Dr. Bit Coupler
- 3/8"F x 1/4"M Adapter
- 1/4"Dr. Spinner Handle

H01005 1500008
15PC. Household Tool Set (2set/ctn)



- 3-Screwdrivers
- Flat 5mm x 100mm
- Phillips #1 x 100mm
- Detection (Pocket Model) 145mm
- 12-Accessories
- Adjustable Wrench / Dipping Grip 8"
- Long Nose Pliers 6"
- Linesman Pliers 6"
- Insulated Tape
- Fine Point Tweezer
- Tape Measure 3m x 13mm
- Utility Knife
- Scissors
- Alum Flashlight 5#
- Mini Hacksaw
- Claw Hammer W / Wood Handle 7 Oz
- Plastic Box

H01003 1500006
19PC. Service Tool Set (8set/ctn)



- Lineman's Plier 6"
- Claw Hammer 7oz
- Mini Hack Saw 6"
- Long Arm Hex Key 1.5 ,2.0,2.5,3.0,4.0,5.0,6.0,8.0mm
- Soft Round Screwdriver Slotted 3x75mm,6x100mm
- Soft Round Screwdriver Phillips #0x75mm,#2x100mm
- Tape Measure 3mx16mm
- Detecting Screwdriver 145mm
- Plastic Cutting Knife 9mm
- Adjustable Wrenches 8"

H01017 1501484
7PC. Household Tool Set (12set/ctn)



- 1- Diagonal Pliers-7"
 - 1- adjustable wrench-8",Cusion Grip
 - 1- double open screwdriver(PH2&6x100MM)
 - 1- Detecting Screwdriver-145MM
 - 1- Measurement Tape(2MMx16MM)
 - 1- Snap-off Utility Knife-8 Seg. 18X100MM Plastic Holder
 - 1- 8oz Claw Hammer-Steel Handle
- Basic tools set, designed for family, technical person daily use.
• Waterproof fabric nylon zipper puller bag for convenient bringing

H01018 1501485
5PC. Household Tool Set (12set/ctn)



- 1- Lineman's Pliers-6"
 - 1- adjustable wrench-8",Cusion Grip
 - 1- double open screwdriver(PH2&6x100MM)
 - 1- Measurement Tape(3MMx16MM)
 - 1- Snap-off Utility Knife-8 Seg. 18X100MM Plastic Holder
- Used for installing and repairing elevator
• Nylon zipper bag for easy use, waterproof fabric.
• Guarantee only for the individual tools, Exclude the zipper bag

H01004 1500007
11PC. Household Tool Set (9set/ctn)



- Adjustable Wrench 8"
- 2 In 1 Reversible-Blades Screwdriver Slotted & Phillips # 1 & 5MMx100MM
- 2 In 1 Reversible-Blades Screwdriver Slotted & Phillips # 2 & 6MMx150MM
- Detecting Screwdriver 185MM
- Lineman's Plier 6"
- Long Nose Plier 6"
- Tape Measure 3mx16mm
- Plastic Cutting Knife 18mm
- Claw Hammer 1/2 lb
- Mini Hash Saw 6"
- LED Flashlight



Mainly for the house work, property management basic repair requirement

Waterproof fabric nylon handle zipper puller bag for convenient bringing

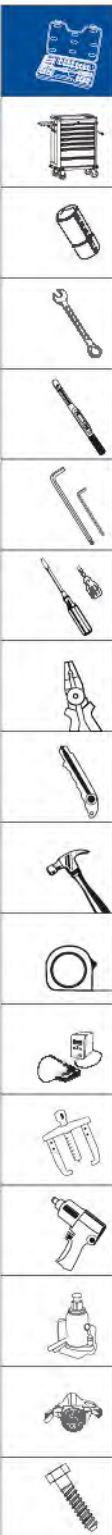

H01020 1501487
9Pc Householding Tool Set (6set/ctn)



- 1- Long Nose Pliers-6"
- 1- Lineman's Pliers-6"
- 1- Adjustable Wrenches-Cusion Grip,8"
- 1- Multi-Bit Screwdriver PH2&6x38MM
- 1- Measuring Tape 3MMx16MM
- 1- Utility Knife-8 Seg. 18X100MM Plastic Holder
- 1- 8oz Claw Hammer-Steel Handle
- 1- Detecting Screwdriver 145MM
- 1- Aluminum Flashlight-Two 5# Battery

Basic tools set, designed for family, technical person daily use.

Nylon zipper bag for easy use, waterproof fabric.

H01022 1501489
11Pc Auto Repair Tool Set (6set/ctn)



- 1- 12.5MM Adjustable L-Handle
- 2- 12.5MM Double Flexible Socket Wrench (17x19,21x23MM)
- 1- Adjustable Wrenches-Cusion Grip,8"
- 1- Multi-Bit Screwdriver PH2&6x38MM
- 1- Measuring Tape 3MMx16MM
- 1- Utility Knife-8 Seg. 18X100MM Plastic Holder
- 1- 8oz Claw Hammer-Steel Handle
- 1- Detecting Screwdriver 145MM
- 1- Aluminum Flashlight-Two 5# Battery

Basic tools set, designed for family, technical person daily use.

Nylon zipper bag for easy use, waterproof fabric.

H01021 1501488
27PC. Householding Tool Set (6set/ctn)



- 1- Long Nose Polier-6"
- 1- Linesman's Polier-6"
- 1- Adjustable Wrench-8",Cusion Grip
- 1- Multi-Bit Screwdriver PH2&6x38MM
- 1- Multi-Bit Screwdriver PH1&6x100MM
- 1- Measuring Tape 3MMx16MM
- 1- Snap-off Utility Knife-8 Seg. 18X100MM Plastic Holder
- 1- Claw Hammer-8oz Metal Handle
- 1- Detecting Screwdriver-145MM
- 1- Aluminum Flashlight-Two 5# Battery
- 6- slot and phillips scwdriver
- 8- Foldeable hex key set
- 1- Flat File- 215MM
- 1- Mini Hack Saw Handle-6"
- 1- PVC Adhesive Tape

Basic tools set, designed for family, technical person daily use.

Nylon zipper bag for easy use, waterproof fabric.

H02110 1501533
Tool set, Tray-8Pc File (6set/ctn)

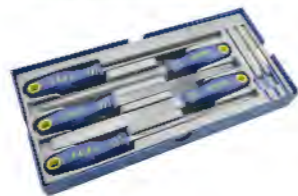

- 1-Flat File-Bastard 8"
- 1-Half Round File-Second 8"
- 1-Square File-Second 8"
- 1-Round File-Second 8"
- 1-Three Square File-Second 8"
- 1-Flat Diamond File 3x140MM Flat Point
- 1-Half Round Diamond File-3x140MM Sharp Point
- 1-Round Diamond File-3x140MM Sharp Point

• Case Size : 390x185x45MM

• H03100 Tool Chest Drawer could fit 3 tool cases.

H01025 1501492
33 Pc Elevator Repairing Set (2set/ctn)



- 1- Adjustable Wrench-10"
- 4- Combination Wrench-Full Polish(10,13,16,18MM)
- 3- Double Open Combination Wrench-Full Polish (8x10,12x14,17x19MM)
- 1- Go-Through Screwdriver -Slot,8X200MM
- 2- Screwdriver-Slot,5x75MM, 6x150MM
- 2- Screwdriver-Phillips,(PH1x75MM, PH2x150MM)
- 1- T-Handle Hex Key 5MM
- 9- Long Hex Key(1.5,2,2.5,3,4,5,6,8,10MM)
- 1- Lineman's Pliers-8"
- 1- Nose Pliers-6"
- 1- Diagonal Pliers-5"
- 1- Circlip Pliers-5" Int. Bent
- 1- Measuring Tape-5x19MM
- 1- Ruler-150MM
- 1- Snap-off Utility Knife-8 Seg. 18X100MM Plastic Holder
- 1- Brush-Wood Handle,2"
- 1- Detecting Screwdriver-185MM
- 1- Aluminum Flashlight-Three 7# Battery

Used for repairing and installing elevator

Technical Case for easy bringing, especially for the outside working person.

H02112 1501535
Tool set, Tray-4Pc Pliers (6set/ctn)



- 1-Long Flat Nose Pliers-6"
- 1-Diagonal Cutting Pliers-6"
- 1-Cutting Pliers-8"
- 1-Plastic Nozzle Pliers-6"

• Case Size : 390x185x45MM

• H03100 Tool Chest Drawer could fit 3 tool cases.

H02101 1501524
Tool set, Tray -66Pc 6.3MM dr. Socket (3set/ctn)



- 14- 6.3MM Socket, 6 point (3.5,4,4.5,5,5.5,6,7,8,9,10,11,12,13,14MM)
- 14- 6.3MM Long Socket, 6 point (4,4.5,5,5.5,6,7,8,9,10,11,12,13,14MM)
- 23- 6.3MM Bit Socket Slot(4,5,5.6,5MM) Phillips(PH1,PH2,PH3) Pozidriv (PZ1,PZ2,PZ3) Star(T8,T10,T15,T20,T25,T27,T30,T40) Hex(3,4,5,6,7,8MM)
- 8- 6.3MM Long Bit Socket Slot(3,4,5,6MM) Phillips(#1,#2,#3)
- 1- 6.3MM Driver
- 1- 6.3MM Quick-Release Ratchet
- 1- 6.3MM Extension Bar-2"
- 1- 6.3MM End Extension Bar-4"
- 1- 6.3MM Sliding T-Handle
- 1- 6.3MM Universal Joint
- 1- 6.3MM Flexible Extension Adapotr-6"
- 1- 6.3MM Magnetic Quick Release Bit Holder
- 1- 6.3MM Bit Holder
- Case Size:390x185x45MM
- H03100 Tool Chest Drawer could fit 3 tool cases.

H02102 1501525
Tool set, Tray -33Pc 10MM dr. Socket (3set/ctn)



- 15- 10MM Socket, 6 point (8,9,10,11,12,13,14,15,16,17,18,19,21,22,24MM)
- 8- 10MM Long Socket, 6 point (10,11,12,13,14,15,17,19MM)
- 3- 10MM Spark Plug Socket (16,18,21MM)
- 1- 10MM Quick-Release Ratchet
- 1- 10MM Extension Bar-10"
- 1- 10MM Dr Adaptor Socket-10MM Female X 6.3MM Male
- 1- 10MM Universal Joint
- 1- 10MM Bit Holder-1/4"
- 1- 10MM Locked Extension Bar-3"
- 1- 12.5MM Dr Adaptor Socket-10MM Female(Hole)X12.5MM Male, 3 Way
- Case Size:390x185x45MM
- H03100 Tool Chest Drawer could fit 3 tool cases.

H02103 1501526
Tool set, Tray -27Pc 12.5MM dr. Socket (3set/ctn)



- 17- 12.5MM Socket, 6 point (10,11,12,13,14,15,16,17,18,19,21,22,24,27,30,32,34)
- 5- 12.5MM Long Socket, 6 point (10,13,17,19,22)
- 1- 12.5MM Quick-Release Ratchet
- 1- 12.5MM Extension Bar-10"
- 1- 12.5MM Universal Joint
- 1- 12.5MM Locked Extension Bar-5"
- 1- 12.5MM Adaptor Socket-12.5MM Female (Hole)X10MM Male, 3 Way
- Case Size:390x185x45MM
- H03100 Tool Chest Drawer could fit 3 tool cases.

H02104 1501527
Tool Set, Tray-10Pc Double Open End and Combination Wrench-Full Polish (3set/ctn)



- 2- Combination Wrench-Full Polish (13,14MM)
- 8- Double Open End Wrench-Full Polish (6x7,8x10,10x12,11x13,12x14,22x24,24x27,30x32MM)
- Case Size:390x185x45MM
- H03100 Tool Chest Drawer could fit 3 tool cases.

H02105 1501528
Tool Set, Tray-10Pc Double Box End Wrench-Full Polish (3set/ctn)



- 10- Double Box End Wrench-Full Polish, 45 Degree (6x7,8x10,10x12,11x13,12x14,14x17,17x19,19x21,21x23,24x27MM)
- Case Size:390x185x45MM
- H03100 Tool Chest Drawer could fit 3 tool cases.

H02106 1501529
Tool Set, Tray-30Pc Combination Wrench & Allen Key (3set/ctn)



- 12- Full Polish Combination Wrench (8,9,10,11,12,13,14,15,16,17,18,19MM)
- 9- Long Ball End Hex Key (1.5,2,2.5,3,4,5,6,8,10MM)
- 9- Long Security Star Key (T10,T15,T20,T25,T27,T30,T40,T45,T50MM)
- Tool Case Size:390x185x45MM
- H03100 Tool Chest Drawer could fit 3 tool cases.

H02107 1501530
Tool Set, Tray-8Pc Combination Wrench-Full Polish (3set/ctn)



- 8- Combination Wrenches-Full Polish (5.5, 6, 7, 20, 21, 22, 23, 24)
- Case Size:390x185x45MM
- H03100 Tool Chest Drawer could fit 3 tool cases.

H02108 1501531
Tool Set, Tray-18Pc Combination Wrench-Full Polish (3set/ctn)



- 15- Combination Wrenches-Full Polish (5.5,6,7,8,9,10,11,12,13,14,15,16,17,18,19MM)
- 3- Adaptor for 10MM Ratcheting Wrench(1/4",3/8",1/2")
- 1- 10MM Bit Holder for 10MM Ratcheting Wrench
- Case Size:390x185x45MM
- H03100 Tool Chest Drawer could fit 3 tool cases.

H02109 1501532
Tool Set, Tray-5Pc Adjustable Wrench & Pliers (3set/ctn)



- 1- Adjustable Wrench 8"
- 1- adjustable Wrench 10"
- 1- Long Nose Plier6"
- 1- Locking Pliers-7" Curved Jaw With Cutter
- 1- Locking Pliers-6" Long Nose With Cutter
- Case Size:390x185x45MM
- H03100 Tool Chest Drawer could fit 3 tool cases.

H02111 1501534
Tool set, Tray -4Pc Circlip Pliers (3set/ctn)



- 1- Circlip Pliers-175MM Ext. Straight
- 1- Circlip Pliers-175MM Ext. Bent
- 1- Circlip Pliers-175MM Int. Straight
- 1- Circlip Pliers-175MM Int. Bent
- Case Size:390x185x45MM
- H03100 Tool Chest Drawer could fit 3 tool cases.

H02115 1501538
Tool set, Tray -26Pc 12.5MM Dr Socket (3set/ctn)



- 20- 12.5MM Dr. Ssocket Wrench,6 point (8,9,10,11,12,13,14,15,16,17,18,19,20,21,22,23,24, 27,30,32MM)
- 5- 12.5MM Dr. Long Ssocket Wrench, 6 point (14,17,19,21,24MM)
- 1- 12.5MM Quick Release Ratchet
- Case Size:390x185x45MM
- H03100 Tool Chest Drawer could fit 3 tool cases.

H02114 1501537
Tool set, Tray -36Pc 3/8"&1/2" Dr Impact Socket (3set/ctn)



- 16- 1/2" Impact Socket (10,11,12,13,14,15,16,17,18,19,21,22,24,27,30,32 MM)
- 12- 3/8" Impact Socket (7,8,9,10,11,12,13,14,15,16,17,18,19MM)
- 1- 3/8" Long Impact Extension Bar-75MM
- 1- 3/8" x1/4" Impact adaptor(MxF)
- 1- 3/8" x1/2" Impact adaptor(MxF)
- 1- 1/2" Long Impact Extension Bar-150MM
- 1- 1/2" x3/8" Impact adaptor(MxF)
- 1- 3/8" x3/4" Impact adaptor(MxF)
- 1- Impact Universal Joint 1/2"x1/2"(MxF)
- Case Size:390x185x45MM
- H03100 Tool Chest Drawer could fit 3 tool cases.

H02113 1501536
Tool set, Tray -13Pc Screwdriver (3set/ctn)



- 4- Precision Screwdriver-Slot (1.0x40,2.0x40,2.5x40,3.0x40)
- 2- Precision Screwdriver-Phillips (PH000x40MM,PH0x40MM)
- 3- Rubber handle Screwdriver-Slot (3x80MM,5x80MM,6x100MM)
- 4- Rubber handle Screwdriver-Phillips (PH0x80MM,PH1x80MM,PH2x100MM,PH3x150MM)
- Case Size:390x185x45MM
- H03100 Tool Chest Drawer could fit 3 tool cases.



7 Drawer Tool Chest



EBS No.	Item No.	L(mm)	W(mm)	H(mm)	NW(kg)
1500046	HC3100	680	458	860	73

DESCRIPTION:

Double ball bearing slides on large drawers
 Caster and body reinforcement for stronger design
 Two swivel and two fixed pin bearing casters for longer use , with 500kg load capacity

2 Drawer Tool Chest



EBS No.	Item No.	L(mm)	W(mm)	H(mm)	NW(kg)
1500050	HC3104	700	340	840	48

DESCRIPTION:

Easy move, full drawer extension ball bearing slides on all drawers
 With protective drawer liner in every drawer
 Internal locking key system

8 Drawer Tool Chest



EBS No.	Item No.	L(mm)	W(mm)	H(mm)	NW(kg)
1500047	HC3101	1035	457	897	94.3

DESCRIPTION:

Easy move,full drawer extension ball bearing slides on all drawers
 Caster and body reinforcement for stronger design

4 Drawer Tool Chest



EBS No.	Item No.	L(mm)	W(mm)	H(mm)	NW(kg)
1500048	HC3102	890	535	1013	77

DESCRIPTION:

Easy move,full drawer extension ball bearing slides on all drawers
 Caster and body reinforcement for stronger design

Utility Cart

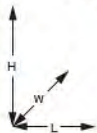

EBS No.	Item No.	L(mm)	W(mm)	H(mm)	NW(kg)
1500049	H03103	845	416	840	24

DESCRIPTION:
 Easy move, full drawer extension ball bearing slides on all drawers
 With protective drawer liner in every drawer
 Internal locking key system

Portable Tool Box-16"



EBS No.	Item No.	L(mm)	W(mm)	H(mm)	NW(kg)
1501610	H03203	420	155	120	1.9

- Easy Move, full drawer extension ball bearing slides on all drawers
- With protective drawer line in every drawer
- Internal locking key system

Tool Chest



EBS No.	Item No.	L(mm)	W(mm)	H(mm)	NW(kg)
1500054	H03200	360	150	115	1.6

DESCRIPTION:
 Easy move, full drawer extension ball bearing slides on all drawers
 With protective drawer liner in every drawer
 Internal locking key system

Tool Chest

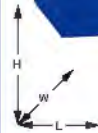

EBS No.	Item No.	L(mm)	W(mm)	H(mm)	NW(kg)
1500055	H03201	428	177	184	3.6

DESCRIPTION:
 Easy move, full drawer extension ball bearing slides on all drawers
 With protective drawer liner in every drawer
 Internal locking key system

Tool Chest



EBS No.	Item No.	L(mm)	W(mm)	H(mm)	NW(kg)
1500056	H03202	508	218	243	5.4

DESCRIPTION:
 Easy move, full drawer extension ball bearing slides on all drawers
 With protective drawer liner in every drawer
 Internal locking key system



Portable Cantilever Tool Box-14" Three shelves

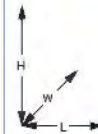

EBS No.	Item No.	L(mm)	W(mm)	H(mm)	NW(kg)
1501611	H03230	350	160	165	2.0

- TRI-Folding design, easy to store
- Anti-construction

Portable Cantilever Tool Box-17" Three shelves

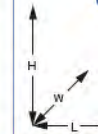

EBS No.	Item No.	L(mm)	W(mm)	H(mm)	NW(kg)
1501612	H03231	430	200	175	3.2

- TRI-Folding design, easy to store
- Anti-construction

Portable Cantilever Tool Box-17" Five shelves

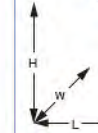

EBS No.	Item No.	L(mm)	W(mm)	H(mm)	NW(kg)
1501613	H03250	430	200	200	4.0

- TRI-Folding design, easy to store
- Anti-construction

Portable Cantilever Tool Box-19" Five shelves

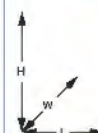

EBS No.	Item No.	L(mm)	W(mm)	H(mm)	NW(kg)
1501614	H03251	495	200	290	5.1

- Five shelves design, High efficiency for tools management
- Zinc plated parkerising steel board, prevent rusting
- Side board thicken:1.2mm
- Strengthen Comfortable Handle

Aluminum Tool Case-16"

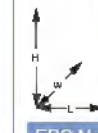

EBS No.	Item No.	L(mm)	W(mm)	H(mm)	NW(kg)
1501345	H03261	425	305	125	2.5

- Popular silver surface(Matte Finish), Corrosion Resistance
- Widen internal metal shelf for tools sotring
- ABS binding on the case cornor, durable for impact
- Include internal EVA divider, easy for seperating

H03262 Aluminum Tool Case-24" Draw-Bar

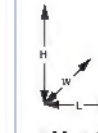

- Max 40kg loading, 7mm steel board, durable for impact
- Include removeable tools pallet, freely for tools storing
- Safety with double lock design, Internal EVR cushion sealed the case
- New design with coffee color board mix silver accessories, different with traditional aluminum tool case

Functional Electrician Wireman Tool Bag-20"



EBS No.	Item No.	L(mm)	W(mm)	H(mm)	NW(kg)
1501627	H03308	400	180	300	1.7

Steel Tube Tool Bag-19"

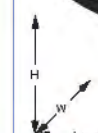

EBS No.	Item No.	L(mm)	W(mm)	H(mm)	NW(kg)
1501628	H03309	400	200	250	1.7

Rolling Tool Bag

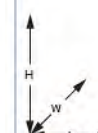

EBS No.	Item No.	L(mm)	W(mm)	H(mm)	NW(kg)
1501629	H03310	440	260	350	4.26

Tool Bag



EBS No.	Item No.	SIZE	L(mm)	W(mm)	H(mm)	pcs case
1501622	H03303	13	300	250	200	20
1501623	H03304	16	380	300	260	20

- 600D durable waterproof polyester Fabric
- Thicken lining, prevent sharp object impale
- Exclude Tools

Tool Bag



EBS No.	Item No.	SIZE	L(mm)	W(mm)	H(mm)	pcs case
1501624	H03305	14	360	300	230	1
1501625	H03306	17	440	330	300	1

- 900D durable waterproof polyester Fabric
- Thicken lining, prevent sharp object impale
- Multiple pocket design, convenience use
- Exclude Tools

Tool Bag



EBS No.	Item No.	SIZE	L(mm)	W(mm)	H(mm)	pcs case
1501626	H03307	16	400	250	220	6

- 600D durable waterproof polyester Fabric
- Thicken lining, prevent sharp object impale
- Exclude Tools

Tool Bag-16"



EBS No.	Item No.	SIZE	L(mm)	W(mm)	H(mm)	pcs case
1501621	H03301	16	400	200	320	1

- 900D waterproof polyester Fabric
- Special design, Durable for impact, easy and convenient using
- the design for the bag will update irregularly, pls refer to the true sample

Tool Backpack



EBS No.	Item No.	SIZE	L(mm)	W(mm)	H(mm)	pcs case
1500057	H03302	350	200	450	5	

- 900D durable waterproof polyester Fabric
- Thicken lining, prevent sharp object impale
- The design for the bag will update irregularly, pls refer to the true sample

Tool Belt And Bag-4 Pocket



EBS No.	Item No.	pcs case
1501631	H03401	5

- Special design for all kinds of tools insatlling
- Open pocket for tools easy taking
- High quality nylon waterproof fabric
- Thicken binding, durable for impact
- Excludes Tools, H03404 need to buy individually

Tool Belt And Bag-6 Pocket



EBS No.	Item No.	pcs case
1501632	H03402	25

- Special designed for All tools carry.
- Easy to take tools with open pocket
- High quality nylon waterproof fabric, high loading
- Thicken binding, durable for impact
- Exclude tools, H03404 need to purchase individually

Tool Belt And Bag-8 Pocket



EBS No.	Item No.	pcs case
1501633	H03403	15

- Special designed for All tools carry.
- Easy to take tools with open pocket
- High quality nylon waterproof fabric, high loading
- Thicken binding, durable for impact
- Exclude tools, H03404 need to purchase individually

Tool Belt



EBS No.	Item No.	pcs case
2600045	H03404	50

- Thicken lining for main component to prevent tearing
- Adjustable belt, suitable for all kinds of users
- High quality nylon waterproof fabric for high loading
- Thicken binding, durable for impact
- Better to use together with H03401,H03402,H03403 tools belt bag
- Include the tape buckle, but excludes Tools,



H02200 1500016
25PC. 1/4" DR. SOCKET SET (METRIC) (12set/ctn)



DESCRIPTION:
14-6pt. Metric Sockets
3.5,4,4.5,5,5.5,6,7,8,9,10,11,12,13,14mm
5-6pt. Metric Deep Sockets 8,10,11,12,13mm
6-Accessories
Quick-Release Ratchet
Spinner Handle
Wobble Extension Bars 2",4"
Sliding T-Bar
Universal Joint

H02202 1500018
58PC. 3/8" DR. SOCKET SET (METRIC) (3set/ctn)



DESCRIPTION:
18-6pt. Metric Sockets
6,7,8,9,10,11,12,13,14,15,16,17,18,19,20,21,22,24mm
9-6pt. Metric Deep Sockets 8,10,11,12,13,14,15,17,19mm
2-Spark Plug Sockets 16,21mm
24- Bit Sockets
Slotted 5.5,6.5,8,0mm
Phillips #1,#2,#3
Pozidriv #1,#2
Torx 10,15,20,25,30,40,45,50,55
Hex 3,4,5,6,7,8,10
5-Accessories
Quick-Release Ratchet
Wobble Extension Bars 3",10"
Universal Joint
1/2"F x 3/8"M 3-Way Adapter

H02204 1500020
46PC. 1/2" DR. SOCKET SET (METRIC & S.A.E.) (3set/ctn)



DESCRIPTION:
20- 6pt. Metric Sockets
8,9,10,11,12,13,14,15,16,17,18,19,20,21,22,23,24,27,,30,32 mm
7-6pt. Metric Deep Sockets 10,12,13,14,15,17,19mm
2-Spark Plug Sockets 16,21mm
11-6pt. S.A.E. Sockets 3/8",7/16",1/2",9/16",5/8",11/16",3/4",13/16",7/8",15/16",1"
6-Accessories
Quick-Release Ratchet
Flex Handle 10"
Wobble Extension Bars 5",10"
Universal Joint
3/8"F x 1/2"M 3-Way Adapter

H02208 1500024
32PC. 1/2" DR. SOCKET SET (METRIC) (2set/ctn)



DESCRIPTION:
21-1/2"Dr. 6PT. Metric Sockets
10,11,12,13,14,15,16,17,18,19,20,21,22,24,27,30,32mm
5-1/2"Dr. 12PT. Metric Sockets 10,12,14,17,19mm
6-Accessories
Quick-Release Ratchet
Wobble Extension Bars 5",10"
Universal Joint
1/2"F x 3/8"M 3-Way Adapter
1/2"Dr. Speed Handle

H02205 1500021
58PC. 1/2" DR. SOCKET SET (METRIC) (3set/ctn)



DESCRIPTION:
17-6PT. Metric Sockets
10,11,12,13,14,15,16,17,18,19,20,21,22,24,27,30,32mm
8-6pt. Metric Deep Sockets 10,11,12,13,14,15,17,19mm
2-Spark Plug Socket 16,21mm
25-5/16"Shank 30L Bits
Slotted 8,10,12
Phillips #1,#2,#3,#4
Pozidriv #1,#2,#3,#4
Torx 20,25,30,40,45,50,55
Hex 4,5,6,8,10,12,14mm
6-Accessories
Quick-Release Ratchet
5/16"Shank x 1/2"Dr. Bit Coupler
Wobble Extension Bars 5",10"
Universal Joint
3/8"F x 1/2"M 3-Way Adapter

H02207 1500023
18PC. 1/4" & 1/2" DR. HEX BIT SOCKET SET (METRIC) (8set/ctn)



DESCRIPTION:
6-1/4"Dr. Bit Sockets
Hex 3,4,5,6,7,8mm
6-1/2"Dr. 50L Bit Sockets
Hex 5,6,7,8,10,12MM
6-1/2"Dr. 100L Bit Sockets
Hex 5,6,7,8,10,12MM

H02209 1500025
3Pc Professional Quick Release Ratchet set (8set/ctn)



- 1-6.3MM Quick Release Ratchet
- 1-10MM Quick Release Ratchet
- 1-12.5MM Quick Release Ratchet

H02201 1500017
38PC. 1/4" DR. SOCKET SET (METRIC) (12set/ctn)



DESCRIPTION:
14-6pt. Metric Sockets
3.5,4,4.5,5,5.5,6,7,8,9,10,11,12,13,14mm
18-Bit Sockets
Slotted 4,0,5,5,6,5
Phillips #1,#2
Pozidriv #1,#2
Torx 10,15,20,25,30,40
Hex 3,4,5,6,8mm
6-Accessories
Quick-Release Ratchet
Spinner Handle
Sliding T-Bar
Universal Joint
Wobble Extension Bars 2",4"

H02203 1500019
20PC. 1/2" DR. SOCKET SET (METRIC) (6set/ctn)



DESCRIPTION:
12-6pt. Metric Sockets
10,11,12,13,14,15,16,17,18,19,22,24mm
3-6pt. Metric Deep Sockets 13,17,19mm
1-Spark Plug Socket 16mm
4-Accessories
Quick-Release Ratchet
Wobble Extension Bar 10"
Universal Joint
3/8"F x 1/2"M 3-Way Adapter

H02206 1500022
15PC. 3/4" DR. SOCKET SET (METRIC) (1set/ctn)



DESCRIPTION:
10- 12pt. Metric Sockets 30,32,34,36,38,41,46,50,55,60mm
5-Accessories
Quick-Release Ratchet
Sliding T-Bar
Extension Bars 4",8"
Universal Joint

QUICK-RELEASE RATCHET

High Torque, Durable for use, easy operate



Each Ratechet has Lock and Quick Release Button, only need to press the button, the socket will be locked, and press one more, the socket will drop



H02210 1501539
23Pc 12.5MM Dr Socket Set-Metric (4set/cbn)



- 1-12.5MM Quick Release Ratchet-Polish Chrome
- 1-12.5MM Extension Bar
- 15-12.5MM Socket Wrench(6 point) (10,11,12,13,14,15,16,17,18,19,22,24,27,30,32,34 MM)
- 4-12.5MM Dr Deep Socket, 6 point(12,14,17,19MM)
- 2-12.5MM Dr Spark Plug Socket(16,21MM)

H02216 1501544
14Pc 10MM Dr Socket Set-Metric (20set/cbn)



- 1-10MM Quick Release Ratchet
- 1-10MM Extension Bar-3"
- 12-10MM Dr. Socket(8,9,10,11,12,13,14,15,16,17,18,19MM)

H02214 1501543
13Pc 6.3MM Dr Socket Set-Metric (20set/cbn)



- 1-6.3MM Quick Release Ratchet
- 1-6.3MM Extension Bar-2"
- 11-6.3MM Dr. Socket(4,5,6,7,8,9,10,11,12,13,14MM)

H02218 1501545
13Pc 12.5MM Dr Socket Set-Metric (0set/cbn)



- 1-12.5MM Quick Release Ratchet
- 1-12.5MM Extension Bar-5"
- 12-12.5MM Dr. Socket(10,11,12,13,14,15,16,17,18,19,22,24MM)

Tools Knowledge



Metric



SAE

Kourling for metric & Beauty ring for SAE. Make user identify easier. Those also help removing the socket from driving tool easily.



Neck down design to fit into tight working space and reduce the weight

6.3MM DR. 6PT. SOCKET (S.A.E.)



EBS No.	Item No.	SIZE	L(mm)	pcs-case
1500137	H21100	5/32"	24.5	12x80
1500138	H21101	3/16"	24.5	12x80
1500139	H21102	7/32"	24.5	12x80
1500140	H21103	1/4"	24.5	12x80
1500141	H21104	9/32"	24.5	12x80
1500142	H21105	5/16"	24.5	12x80
1500143	H21106	11/32"	24.5	12x48
1500144	H21107	3/8"	24.5	12x48
1500145	H21108	7/16"	24.5	6 x48
1500146	H21109	1/2"	24.5	6 x48

6.3MM DR. 6PT. SOCKET (METRIC)

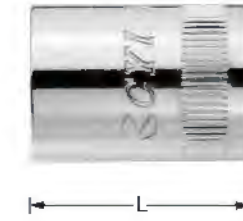

EBS No.	Item No.	SIZE	L(mm)	pcs-case
1500147	H21200	3.5	24.5	12x80
1500148	H21201	4.0	24.5	12x80
1500149	H21202	4.5	24.5	12x80
1500150	H21203	5.0	24.5	12x80
1500151	H21204	5.5	24.5	12x80
1500152	H21205	6.0	24.5	12x80
1500153	H21206	7.0	24.5	12x80
1500154	H21207	8.0	24.5	12x80
1500155	H21208	9.0	24.5	12x48
1500156	H21209	10.0	24.5	12x48
1500157	H21210	11.0	24.5	6 x80
1500158	H21211	12.0	24.5	6 x48
1500159	H21212	13.0	24.5	6 x48
1500160	H21213	14.0	24.5	6 x48

6.3MM DR. 6PT. DEEP SOCKET (S.A.E.)



EBS No.	Item No.	SIZE	L(mm)	pcs-case
1500161	H21300	3/16"	49.0	12x45
1500162	H21301	7/32"	49.0	12x45
1500163	H21302	1/4"	49.0	12x45
1500164	H21303	9/32"	49.0	12x45
1500165	H21304	5/16"	49.0	12x45
1500166	H21305	11/32"	49.0	6 x48
1500167	H21306	3/8"	49.0	6 x48
1500168	H21307	7/16"	49.0	6 x48
1500169	H21308	1/2"	49.0	6 x27

6.3MM DR. 6PT. DEEP SOCKET (METRIC)



EBS No.	Item No.	SIZE	L(mm)	pcs-case
1500170	H21400	4.0	49.0	12x45
1500171	H21401	5.0	49.0	12x45
1500172	H21402	6.0	49.0	12x45
1500173	H21403	7.0	49.0	12x45
1500174	H21404	8.0	49.0	12x45
1500175	H21405	9.0	49.0	6 x48
1500176	H21406	10.0	49.0	6 x48
1500177	H21407	11.0	49.0	6 x48
1500178	H21408	12.0	49.0	6 x48
1500179	H21409	13.0	49.0	6 x27
1501994	H21410	4.5	49.0	12x45
1501995	H21411	5.5	49.0	12x45

6.3MM DR. QUICK-RELEASE RATCHET (TEAR DROP)



EBS No.	Item No.	L(mm)	pcs-case
1500180	H21901	130	4 x15

DESCRIPTION:
Ratchets feature a convenient single hand direction change switch.
Ratchets have quick-release capability to easily eject an engaged socket even under slippery conditions.

6.3MM Dr Quick Release Ratchet-Polish Chrome(Round head)



EBS No.	Item No.	L(mm)	pcs-case
1501398	H21902	130	4 x15

- Ratchets with quick release function, convenient for single hand operating

6.3MM Dr Quick Release Ratchet-Polish Chrome(Pear head)



EBS No.	Item No.	L(mm)	pcs-case
1501996	H21900	130	4 x6

- Quick Release Ratchet,Single hand operation

6.3 MM series light handle grips fast shedding ratchet wrench



EBS No.	Item No.	L(mm)	pcs-case
1507788	H21903	130	4x6

- Quick Release Ratchet,Single hand operation

6.3MM DR. WOBBLE EXTENSION BAR



EBS No.	Item No.	SIZE	L(mm)	pcs-case
1500181	H21910	2"	50	12 x45
1500182	H21911	4"	100	12 x20

DESCRIPTION:
Unique Design for Dual Function.
For wobble Function.
Push in for Standard Extension Bar.

6.3MM Extension Bar

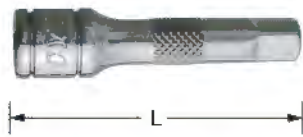

EBS No.	Item No.	SIZE	L(mm)	pcs case
1502000	H21913	2"	50	12x45
1502001	H21914	4"	100	12x45
1502002	H21915	6"	150	8 x45

• Unique design for Dual function

6.3MM DR. FLEX HANDLE



EBS No.	Item No.	SIZE	L(mm)	pcs case
1500183	H21920	6"	140	6 x20

6.3MM DR. FLEX EXTENSION BAR

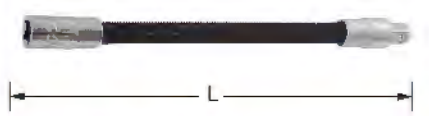

EBS No.	Item No.	SIZE	L(mm)	pcs case
1500189	H21970	1/4"	150	12x20

6.3MM DR. SPINNER HANDLE



EBS No.	Item No.	L(mm)	pcs case
1500185	H21940	150	6x8

Handle could connect with 6.3MM Ratchet Wrench

6.3MM DR. SLIDING T-BAR



EBS No.	Item No.	L(mm)	pcs case
1500184	H21930	110	12x20

6.3MM DR. ADAPTER



EBS No.	Item No.	F	M	pcs case
1500187	H21951	1/4"	3/8"	12x80

6.3MM DR. UNIVERSAL JOINT



EBS No.	Item No.	F	M	pcs case
1500188	H21960	1/4"	1/4"	12x48

10MM DR. 6PT. SOCKET (S.A.E.)



EBS No.	Item No.	SIZE	L(mm)	pcs case
1500190	H22100	1/4"	25.0	6 x 80
1500191	H22101	5/16"	25.0	6 x 80
1500192	H22102	3/8"	25.0	6 x 80
1500193	H22103	7/16"	25.0	6 x 80
1500194	H22104	1/2"	25.0	6 x 48
1500195	H22105	9/16"	25.0	6 x 48
1500196	H22106	5/8"	25.0	6 x 48
1500197	H22107	11/16"	25.0	6 x 27
1500198	H22108	3/4"	25.0	6 x 27
1500199	H22109	13/16"	28.0	4 x 27
1500200	H22110	7/8"	28.0	4 x 27

6.3MM DR. X 6.3MM SHANK BIT COUPLER



EBS No.	Item No.	F	SIZE	pcs case
1500186	H21950	1/4"	1/4"	12x80

10MM DR. 6PT. DEEP SOCKET (S.A.E.)



EBS No.	Item No.	SIZE	L(mm)	pcs case
1500219	H22300	3/8"	63.5	6 x 45
1500220	H22301	7/16"	63.5	6 x 45
1500221	H22302	1/2"	63.5	6 x 27
1500222	H22303	9/16"	63.5	6 x 27
1500223	H22304	5/8"	63.5	6 x 27
1500224	H22305	11/16"	63.5	6 x 16
1500225	H22306	3/4"	63.5	6 x 16
1500226	H22307	13/16"	63.5	4 x 16
1500227	H22308	7/8"	63.5	4 x 16

10MM DR. 6PT. SOCKET (METRIC)



EBS No.	Item No.	SIZE	L(mm)	pcs case
1500201	H22200	6.0	25.0	6 x 80
1500202	H22201	7.0	25.0	6 x 80
1500203	H22202	8.0	25.0	6 x 80
1500204	H22203	9.0	25.0	6 x 80
1500205	H22204	10.0	25.0	6 x 80
1500206	H22205	11.0	25.0	6 x 80
1500207	H22206	12.0	25.0	6 x 80
1500208	H22207	13.0	25.0	6 x 48
1500209	H22208	14.0	25.0	6 x 48
1500210	H22209	15.0	25.0	6 x 48
1500211	H22210	16.0	25.0	6 x 48
1500212	H22211	17.0	25.0	6 x 27
1500213	H22212	18.0	25.0	6 x 27
1500214	H22213	19.0	28.0	6 x 27
1500215	H22214	20.0	28.0	6 x 27
1500216	H22215	21.0	28.0	6 x 27
1500217	H22216	22.0	31.5	4 x 27
1500218	H22217	24.0	31.5	4 x 27

10MM DR. 6PT. DEEP SOCKET (METRIC)



EBS No.	Item No.	SIZE	L(mm)	pcs case
1500228	H22400	8.0	64	6 x 45
1500204	H22401	9.0	64	6 x 45
1500229	H22402	10.0	64	6 x 45
1500230	H22403	11.0	64	6 x 45
1500231	H22404	12.0	64	6 x 45
1500232	H22405	13.0	64	6 x 27
1500233	H22406	14.0	64	6 x 27
1500234	H22407	15.0	64	6 x 27
1500235	H22408	16.0	64	6 x 27
1500236	H22409	17.0	64	6 x 16
1500237	H22410	18.0	64	6 x 16
1500238	H22411	19.0	64	6 x 16

10MM DR. E-TORX SOCKET



EBS No.	Item No.	SIZE	L(mm)	pcs case
1500239	H22500	E4	26.0	6 x 80
1500240	H22501	E5	26.0	6 x 80
1500241	H22502	E6	26.0	6 x 80
1500242	H22503	E7	26.0	6 x 80
1500243	H22504	E8	26.0	6 x 80
1500244	H22505	E10	26.0	6 x 80
1500245	H22506	E11	26.0	6 x 80
1500246	H22507	E12	26.0	6 x 80
1500247	H22508	E14	28.5	6 x 48
1500248	H22509	E16	28.5	6 x 48
1500249	H22510	E18	28.5	6 x 48
1500250	H22511	E20	30.5	6 x 48

10MM DR. QUICK-RELEASE RATCHET (TEAR DROP)



EBS No.	Item No.	L(mm)	pcs case
1500253	H22901	200	4x8

DESCRIPTION:
Ratchets feature a convenient single hand direction change switch.
Ratchets have quick-release capability to easily eject an engaged socket even under slippery conditions.

10MM Dr Quick Release Ratchet-Polish Chrome(Round head)

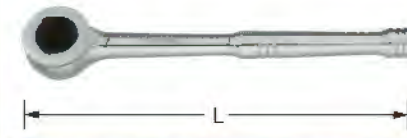

EBS No.	Item No.	L(mm)	pcs case
1501399	H22902	200	4x8

• Ratchets with quick release function, convenient for single hand operating

10MM Dr Quick Release Ratchet-Polish Chrome(Pear head)



EBS No.	Item No.	L(mm)	pcs case
1502007	H22900	200	4x8

• Quick Release Ratchet, Single hand operation

10MM series light handle grips the type professional fast shedding ratchet wrench



EBS No.	Item No.	L(mm)	pcs case
1507789	H22903	200	4x8

• Quick Release Ratchet, Single hand operation

10MM DR. WOBBLE EXTENSION BAR



EBS No.	Item No.	SIZE	L(mm)	pcs case
1500254	H22910	3"	75	6x27
1500255	H22911	6"	150	6x20
1500256	H22912	10"	250	6x8

DESCRIPTION:
Unique Design for Dual Function.
For wobble Function.
Push in for Standard Extension Bar.

10MM DR. FLEX HANDLE



EBS No.	Item No.	SIZE	L(mm)	pcs case
1500257	H22920	8"	140	6x15

10MM Extension Bar

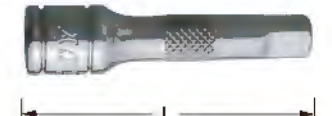

EBS No.	Item No.	SIZE	L(mm)	pcs case
1502010	H22915	3"	75	6x27
1502011	H22916	6"	150	6x20
1502012	H22917	10"	250	6x20

• Unique design for Dual function

10MM DR. SLIDING T-BAR



EBS No.	Item No.	L(mm)	pcs case
1500258	H22930	165	6x15

10MM DR. UNIVERSAL JOINT



EBS No.	Item No.	F	M	pcs case
1500263	H22960	3/8"	3/8"	6x15

10MM DR. ADAPTER



EBS No.	Item No.	F	M	pcs case
1500260	H22951	1/4"	3/8"	6x80
1500261	H22952	1/2"	3/8"	6x48

10MM DR. X 6.3MM SHANK BIT COUPLER



EBS No.	Item No.	F	SIZE	pcs case
1500259	H22950	3/8"	(1/4")	6x80

10MM DR. FLEX EXTENSION BAR



EBS No.	Item No.	SIZE	L(mm)	pcs case
1500264	H22970	3/8"	200	6 x 15

10MM DR. 3-WAY ADAPTER

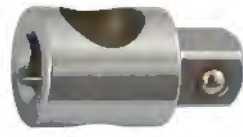

EBS No.	Item No.	M	F	pcs case
1500262	H22953	1/2"	3/8"	6 x 27

10MM Dr Speeder Handle



EBS No.	Item No.	F	pcs case
1501396	H22990	3/8"	2 x 6

12.5MM DR. 6PT. SOCKET (S.A.E.)



EBS No.	Item No.	SIZE	L(mm)	pcs case
1500265	H23100	5/16"	37.8	6 x 48
1502830	H23101	3/8"	37.8	6 x 48
1500267	H23102	7/16"	37.8	6 x 48
1500268	H23103	1/2"	37.8	6 x 48
1500269	H23104	9/16"	37.8	6 x 48
1500270	H23105	5/8"	37.8	6 x 48
1500271	H23106	11/16"	37.8	6 x 27
1500272	H23107	3/4"	37.8	6 x 27
1500273	H23108	13/16"	37.8	4 x 27
1500274	H23109	7/8"	37.8	4 x 27
1500275	H23110	15/16"	37.8	4 x 27
1500276	H23111	1"	40.0	4 x 24
1500277	H23112	1-1/16"	40.0	4 x 24
1500278	H23113	1-1/8"	42.0	4 x 24
1500279	H23114	1-1/4"	42.0	2 x 30

12.5MM DR. 6PT. SOCKET (METRIC)



EBS No.	Item No.	SIZE	L(mm)	pcs case
1500295	H23200	8.0	37.8	6 x 48
1500296	H23201	9.0	37.8	6 x 48
1500297	H23202	10.0	37.8	6 x 48
1500298	H23203	11.0	37.8	6 x 48
1500299	H23204	12.0	37.8	6 x 48
1500300	H23205	13.0	37.8	6 x 48
1500301	H23206	14.0	37.8	6 x 48
1500302	H23207	15.0	37.8	6 x 48
1500303	H23208	16.0	37.8	6 x 48
1500304	H23209	17.0	37.8	6 x 27
1500305	H23210	18.0	37.8	6 x 27
1500306	H23211	19.0	37.8	6 x 27
1500307	H23212	20.0	37.8	6 x 27
1500308	H23213	21.0	37.8	6 x 27
1500309	H23214	22.0	40.0	4 x 27
1500310	H23215	23.0	40.0	4 x 27
1500311	H23216	24.0	40.0	4 x 27
1500312	H23217	27.0	43.0	4 x 24
1500313	H23218	30.0	43.0	4 x 24
1500314	H23219	32.0	43.0	2 x 30
1502017	H23220	34.0	43.0	2 x 30

12.5MM DR. 6PT. DEEP SOCKET (METRIC)



EBS No.	Item No.	SIZE	L(mm)	pcs case
1500349	H23400	10.0	77.0	6 x 27
1500350	H23401	11.0	77.0	6 x 27
1500351	H23402	12.0	77.0	6 x 27
1500352	H23403	13.0	77.0	6 x 27
1500353	H23404	14.0	77.0	6 x 27
1500354	H23405	15.0	77.0	6 x 27
1500355	H23406	16.0	77.0	6 x 27
1500356	H23407	17.0	77.0	6 x 16
1500357	H23408	18.0	77.0	6 x 16
1500358	H23409	19.0	77.0	6 x 16
1500359	H23410	20.0	77.0	4 x 16
1500360	H23411	21.0	77.0	4 x 16
1500361	H23412	22.0	77.0	4 x 16
1500362	H23413	24.0	77.0	4 x 16
1500363	H23414	27.0	77.0	4 x 12
1500364	H23415	30.0	77.0	2 x 16
1500365	H23416	32.0	77.0	2 x 16

12.5MM DR. 6PT. DEEP SOCKET (S.A.E.)



EBS No.	Item No.	SIZE	L(mm)	pcs case
1500335	H23300	3/8"	77.0	6 x 27
1500336	H23301	7/16"	77.0	6 x 27
1500337	H23302	1/2"	77.0	6 x 27
1500338	H23303	9/16"	77.0	6 x 27
1500339	H23304	5/8"	77.0	6 x 27
1500340	H23305	11/16"	77.0	6 x 16
1500341	H23306	3/4"	77.0	6 x 16
1500342	H23307	13/16"	77.0	4 x 16
1500343	H23308	7/8"	77.0	4 x 16
1500344	H23309	15/16"	77.0	4 x 12
1500345	H23310	1"	77.0	4 x 12
1500346	H23311	1-1/16"	77.0	4 x 12
1500347	H23312	1-1/8"	77.0	4 x 12
1500348	H23313	1-1/4"	77.0	2 x 16

12.5MM DR. 12PT. SOCKET (S.A.E.)



EBS No.	Item No.	SIZE	L(mm)	pcs case
1500280	H23140	5/16"	37.8	6 x 48
1500281	H23141	3/8"	37.8	6 x 48
1500282	H23142	7/16"	37.8	6 x 48
1500283	H23143	1/2"	37.8	6 x 48
1500284	H23144	9/16"	37.8	6 x 48
1500285	H23145	5/8"	37.8	6 x 48
1500286	H23146	11/16"	37.8	6 x 27
1500287	H23147	3/4"	37.8	6 x 27
1500288	H23148	13/16"	37.8	6 x 27
1500289	H23149	7/8"	37.8	4 x 27
1500290	H23150	15/16"	37.8	4 x 27
1500291	H23151	1"	40.0	4 x 24
1500292	H23152	1-1/16"	40.0	4 x 24
1500293	H23153	1-1/8"	42.0	4 x 24
1500294	H23154	1-1/4"	42.0	2 x 30

12.5MM DR. 12PT. SOCKET (METRIC)



EBS No.	Item No.	SIZE	L(mm)	pcs case
1500315	H23240	8.0	37.8	6 x 48
1500316	H23241	9.0	37.8	6 x 48
1500317	H23242	10.0	37.8	6 x 48
1500318	H23243	11.0	37.8	6 x 48
1500319	H23244	12.0	37.8	6 x 48
1500320	H23245	13.0	37.8	6 x 48
1500321	H23246	14.0	37.8	6 x 48
1500322	H23247	15.0	37.8	6 x 48
1500323	H23248	16.0	37.8	6 x 48
1500324	H23249	17.0	37.8	6 x 27
1500325	H23250	18.0	37.8	6 x 27
1500326	H23251	19.0	37.8	6 x 27
1500327	H23252	20.0	37.8	6 x 27
1500328	H23253	21.0	37.8	6 x 27
1500329	H23254	22.0	37.8	4 x 27
1500330	H23255	23.0	37.8	4 x 27
1500331	H23256	24.0	37.8	4 x 27
1500332	H23257	27.0	40.0	4 x 24
1500333	H23258	30.0	42.0	4 x 24
1500334	H23259	32.0	42.0	2 x 30

12.5MM DR. E-TORX SOCKET



EBS No.	Item No.	SIZE	L(mm)	pcs case
1500366	H23500	E10	38.0	6 x 48
1500367	H23501	E12	38.0	6 x 48
1500368	H23502	E14	38.0	6 x 48
1500369	H23503	E16	38.0	6 x 48
1500370	H23504	E18	38.0	6 x 27
1500371	H23505	E20	38.0	4 x 27
1500372	H23506	E22	38.0	4 x 27
1500373	H23507	E24	40.0	4 x 27

12.5MM DR. QUICK-RELEASE RATCHET (TEAR DROP)



EBS No.	Item No.	L(mm)	pcs case
1500376	H23901	250	4 x 6

DESCRIPTION:
Ratchets feature a convenient single hand direction change switch.
Ratchets have quick-release capability to easily eject an engaged socket even under slippery conditions.

12.5MM Dr Quick Release Ratchet-Polish Chrome(Round head)

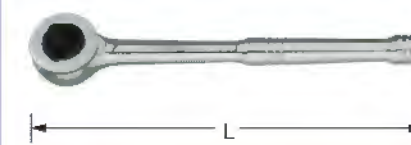

EBS No.	Item No.	L(mm)	pcs case
1501400	H23902	250	4 x 6

• Ratchets with quick release function, convenient for single hand operating

12.5MM Dr Quick Release Ratchet-Polish Chrome(Pear head)



EBS No.	Item No.	L(mm)	pcs case
1502018	H23900	250	4 x 6

• Quick Release Ratchet, Single hand operation

12.5MM DR. WOBBLE EXTENSION BAR



EBS No.	Item No.	SIZE	L(mm)	pcs case
1500377	H23910	5"	125	4 x 20
1500378	H23911	10"	250	4 x 8

DESCRIPTION:
Unique Design for Dual Function.
For wobble Function.
Push in for Standard Extension Bar.

12.5MM Extension Bar

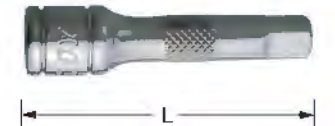

EBS No.	Item No.	SIZE	L(mm)	pcs case
1502021	H23913	5"	125	4 x 20
1502022	H23914	10"	250	4 x 8

• Unique design for Dual function

12.5MM DR. FLEX HANDLE



EBS No.	Item No.	SIZE	L(mm)	pcs case
1500379	H23920	10"	250	4 x 8
1500380	H23921	15"	375	4 x 6

12.5MM DR. SLIDING T-BAR



EBS No.	Item No.	L(mm)	pcs case
1500381	H23930	250	4 x 8

12.5MM DR. UNIVERSAL JOINT



EBS No.	Item No.	F	M	pcs case
1500385	H23960	1/2"	1/2"	4 x 8

12.5MM DR. ADAPTER



EBS No.	Item No.	F	M	pcs-case
1500383	H23951	1/2"	3/8"	4 x 48

12.5MM DR. X 6.3MM BIT COUPLER



EBS No.	Item No.	F	SIZE	pcs-case
1500382	H23950	1/2"	5/16"	6 x 27

12.5MM DR. 3-WAY ADAPTER



EBS No.	Item No.	M	F	pcs-case
1500384	H23953	3/8"	1/2"	4 x 48

12.5MM Dr Speeder Handle 385MM



EBS No.	Item No.	F	pcs-case
1500386	H23990	1/2"	4 x 48

12.5MM Dr L-Handle 10"



EBS No.	Item No.	F	pcs-case
1501397	H23980	1/2"	6 x 6

19MM DR. 12PT. SOCKET (METRIC)



EBS No.	Item No.	SIZE	L(mm)	pcs-case
1500387	H24240	19.0	50.0	8 x 8
1500388	H24241	21.0	50.0	8 x 8
1500389	H24242	22.0	50.0	10x6
1500390	H24243	23.0	50.0	10x6
1500391	H24244	24.0	51.0	10x6
1500392	H24245	25.0	52.0	10x6
1500393	H24246	26.0	52.0	10x6
1500394	H24247	27.0	52.0	10x6
1500395	H24248	28.0	52.0	8 x 6
1500396	H24249	29.0	54.0	8 x 6
1500397	H24250	30.0	56.0	8 x 6
1500398	H24251	32.0	56.0	6 x 8
1500399	H24252	33.0	56.0	6 x 8
1500400	H24253	34.0	56.0	6 x 6
1500401	H24254	35.0	58.0	6 x 6
1500402	H24255	36.0	58.0	6 x 6
1500403	H24256	38.0	60.0	4 x 8
1500404	H24257	41.0	64.0	4 x 8
1500405	H24258	46.0	68.0	4 x 8
1500406	H24259	50.0	72.0	2 x 8
1500407	H24260	55.0	76.0	2 x 8
1500408	H24261	60.0	78.0	2 x 8

19MM DR. QUICK-RELEASE RATCHET (Round head)



EBS No.	Item No.	SIZE	L(mm)	pcs-case
1500409	H24900	20"	500	1 x 6

DESCRIPTION:
Ratchets feature a convenient single hand direction change switch.
Ratchets have quick-release capability to easily eject an engaged socket even under slippery conditions.

19MM DR. WOBBLE EXTENSION BAR



EBS No.	Item No.	SIZE	L(mm)	pcs-case
1500410	H24910	4"	100	6 x 6
1500411	H24911	8"	200	3 x 6
1500412	H24912	16"	400	2 x 6

DESCRIPTION:
Unique Design for Dual Function.
For wobble Function.
Push in for Standard Extension Bar.

19MM DR. FLEX HANDLE



EBS No.	Item No.	L(mm)	pcs-case
1500413	H24920	450	2 x 6

19MM DR. SLIDING T-BAR

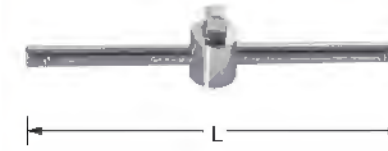

EBS No.	Item No.	L(mm)	pcs-case
1500414	H24930	450	2 x 6

19MM DR. UNIVERSAL JOINT



EBS No.	Item No.	M	F	pcs-case
1500415	H24960	3/4"	3/4"	3 x 6

19MM Dr L-Handle



EBS No.	Item No.	L(MM)	F	pcs-case
1500416	H24980	330	3/4"	4 x 8

Tools Knowledge

Metric and SAE Comopare List

SAE	Metric
1/16"	1.59mm
1/8"	3.18mm
3/16"	4.76mm
1/4"	6.35mm
5/16"	7.94mm
3/8"	9.53mm
7/16"	11.11mm
1/2"	12.70mm
9/16"	14.29mm
5/8"	15.88mm
11/16"	17.46mm
3/4"	19.05mm
13/16"	20.64mm
7/8"	22.23mm
15/16"	23.81mm
1"	25.40mm
1-1/16"	26.99mm
1-1/8"	28.58mm
1-3/16"	30.16mm
1-1/4"	31.75mm
1/4"	6.3mm
3/8"	10mm
1/2"	12.5mm
3/4"	20mm

Metric hex bolt and socket wrench across size compare list

Metric hex bolt size	socket wrench across size	Metric hex bolt size	socket wrench across size
M3	5.5mm	M27	41mm
M4	7mm	M30	46mm
M5	8mm	M33	50mm
M6	10mm	M36	55mm
M8	13mm(14mm)	M39	60mm
M8	16mm(17mm)	M42	65mm
M12	18mm(19mm)	M45	70mm
M14	21mm(22mm)	M48	75mm
M16	24mm	M52	80mm
M18	27mm	M56	85mm
M20	30mm	M60	90mm
M22	34mm	M64	95mm
M24	36mm		

Socket Accessorys

Catalog	Sub-Catalog	Function
Extensin Bar	Extension Bar	For Extension Use
	Lock Extension Bar	For Lock and extension use
	Bend Extension Bar	For Bend and extension use
Driver Accessorys	Driving	
	Spinner Handle	Screwdriver Shape
	Sliding T-Bar	Sliding Driving
	Flex Handle	
Universal Joint	L-Handle	Add Power
	Speeder Handle	
	Universla Joint	
	Speedy Rotation	For All Orientation Use
	Bit Holder	

Bit Socket Advantage



- 1 High quality S2 material bit, full quenching, durable for impact
- 2 Include 50MM and 100MM two size, for special working use
- 3 Hex Bit insert in the socket, prevent slipping



- 4 High torque with CR-V material
- 5 Include 6.3MM, 10MM and 12.5MM three size

Bit Socket Style



6.3MM DR. SLOTTED BIT SOCKET



EBS No.	Item No.	SIZE	L(mm)	pcs/case
1500417	H25100	4.0mm	37.0	12 x 45
1500418	H25101	5.5mm	37.0	12 x 45
1500419	H25102	6.5mm	37.0	12 x 45

High quality S2 material bit, full quenching, durable for impact

6.3MM DR. POZI-DRIVE BIT SOCKET



EBS No.	Item No.	SIZE	L(mm)	pcs/case
1500436	H25500	PZ1	37.0	12 x 45
1500437	H25501	PZ2	37.0	12 x 45
1500438	H25502	PZ3	37.0	12 x 45

High quality S2 material bit, full quenching, durable for impact

6.3MM DR. HEX BIT SOCKET



EBS No.	Item No.	SIZE	L(mm)	pcs/case
1500430	H25400	3.0mm	37.0	12 x 45
1500431	H25401	4.0mm	37.0	12 x 45
1500432	H25402	5.0mm	37.0	12 x 45
1500433	H25403	6.0mm	37.0	12 x 45
1500434	H25404	8.0mm	37.0	12 x 45
1500435	H25405	7.0mm	37.0	12 x 45

High quality S2 material bit, full quenching, durable for impact

10MM DR. PHILLIPS BIT SOCKET



EBS No.	Item No.	SIZE	L(mm)	pcs/case
1500443	H26200	PH1	50.0	6 x 45
1500444	H26201	PH2	50.0	6 x 45
1500445	H26202	PH3	50.0	6 x 45

High quality S2 material bit, full quenching, durable for impact

10MM DR. HEX BIT SOCKET



EBS No.	Item No.	SIZE	L(mm)	pcs/case
1500457	H26400	3.0mm	50.0	6 x 45
1500458	H26401	4.0mm	50.0	6 x 45
1500459	H26402	5.0mm	50.0	6 x 45
1500460	H26403	6.0mm	50.0	6 x 45
1500461	H26404	7.0mm	50.0	6 x 45
1500462	H26405	8.0mm	50.0	6 x 45
1500463	H26406	10.0mm	50.0	6 x 45

High quality S2 material bit, full quenching, durable for impact

6.3MM DR. PHILLIPS BIT SOCKET



EBS No.	Item No.	SIZE	L(mm)	pcs/case
1500420	H25200	PH1	37.0	12 x 45
1500421	H25201	PH2	37.0	12 x 45
1500422	H25202	PH3	37.0	12 x 45

High quality S2 material bit, full quenching, durable for impact

6.3MM DR. TORX BIT SOCKET

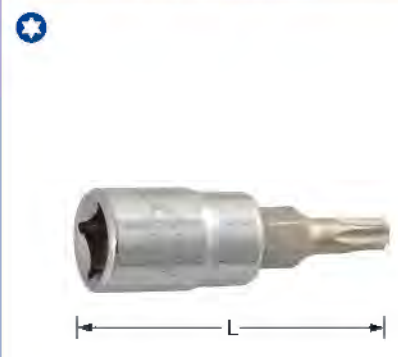

EBS No.	Item No.	SIZE	L(mm)	pcs/case
1500423	H25300	T8	37.0	12 x 45
1500424	H25301	T10	37.0	12 x 45
1500425	H25302	T15	37.0	12 x 45
1500426	H25303	T20	37.0	12 x 45
1500427	H25304	T25	37.0	12 x 45
1500428	H25305	T30	37.0	12 x 45
1500429	H25306	T40	37.0	12 x 45
1502029	H25307	T27	37.0	12 x 45

High quality S2 material bit, full quenching, durable for impact

10MM DR. SLOTTED BIT SOCKET



EBS No.	Item No.	SIZE	L(mm)	pcs/case
1500439	H26100	4.0mm	50.0	6 x 45
1500440	H26101	5.5mm	50.0	6 x 45
1500441	H26102	6.5mm	50.0	6 x 45
1500442	H26103	8.0mm	50.0	6 x 45

High quality S2 material bit, full quenching, durable for impact

10MM DR. TORX BIT SOCKET



EBS No.	Item No.	SIZE	L(mm)	pcs/case
1500446	H26300	T10	50.0	6 x 45
1500447	H26301	T15	50.0	6 x 45
1500448	H26302	T20	50.0	6 x 45
1500449	H26303	T25	50.0	6 x 45
1500450	H26304	T27	50.0	6 x 45
1500451	H26305	T30	50.0	6 x 45
1500452	H26306	T40	50.0	6 x 45
1500453	H26307	T45	50.0	6 x 45
1500454	H26308	T50	50.0	6 x 45
1500455	H26309	T55	50.0	6 x 45
1500456	H26310	T60	50.0	6 x 45

High quality S2 material bit, full quenching, durable for impact

10MM DR. POZI-DRIVE BIT SOCKET



EBS No.	Item No.	SIZE	L(mm)	pcs/case
1500464	H26500	PZ1	50.0	6 x 45
1500465	H26501	PZ2	50.0	6 x 45
1500466	H26502	PZ3	50.0	6 x 45

High quality S2 material bit, full quenching, durable for impact

10MM DR. TORX BIT SOCKET(TAMPER-PROOF)



EBS No.	Item No.	SIZE	L(MM)	pcs-case
1500467	H26600	T45	50.0	6 x 45
1500468	H26601	T50	50.0	6 x 45
1500469	H26602	T55	50.0	6 x 45
1500470	H26603	T60	50.0	6 x 45

S-2 High quality alloy steel, Integral quenching, Uneasy to break and slip
For technical go-through head star screw

12.5MM DR. SPLINE BIT SOCKET



EBS No.	Item No.	SIZE	L(MM)	pcs-case
1500507	H27710	M5	50.0	6 x 24
1500508	H27711	M6	50.0	6 x 24
1500509	H27712	M8	50.0	6 x 24
1500510	H27713	M10	50.0	6 x 24
1500511	H27714	M12	50.0	6 x 24
1500512	H27715	M14	50.0	6 x 24
1500513	H27716	M16	50.0	6 x 24

S-2 High quality alloy steel, Integral quenching, Uneasy to break and slip

12.5MM DR. 100L SPLINE BIT SOCKET

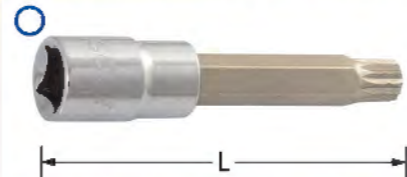

EBS No.	Item No.	SIZE	L(MM)	pcs-case
1500514	H27720	M5	100.0	6 x 16
1500515	H27721	M6	100.0	6 x 16
1500516	H27722	M8	100.0	6 x 16
1500517	H27723	M10	100.0	6 x 16
1500518	H27724	M12	100.0	6 x 16
1500519	H27725	M14	100.0	6 x 16
1500520	H27726	M16	100.0	6 x 16

S-2 High quality alloy steel, Integral quenching, Uneasy to break and slip

12.5MM DR. 50L TORX BIT SOCKET



EBS No.	Item No.	SIZE	L(MM)	pcs-case
1500471	H27310	T20	50.0	6 x 24
1500472	H27311	T25	50.0	6 x 24
1500473	H27312	T27	50.0	6 x 24
1500474	H27313	T30	50.0	6 x 24
1500475	H27314	T40	50.0	6 x 24
1500476	H27315	T45	50.0	6 x 24
1500477	H27316	T50	50.0	6 x 24
1500478	H27317	T55	50.0	6 x 24
1500479	H27318	T60	50.0	6 x 24

S-2 High quality alloy steel, Integral quenching, Uneasy to break and slip

12.5MM DR. 100L TORX BIT SOCKET

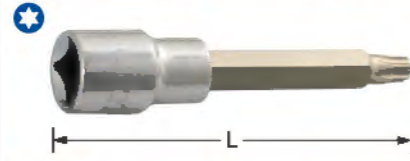

EBS No.	Item No.	SIZE	L(MM)	pcs-case
1500480	H27320	T20	100.0	6 x 16
1500481	H27321	T25	100.0	6 x 16
1500482	H27322	T27	100.0	6 x 16
1500483	H27323	T30	100.0	6 x 16
1500484	H27324	T40	100.0	6 x 16
1500485	H27325	T45	100.0	6 x 16
1500486	H27326	T50	100.0	6 x 16
1500487	H27327	T55	100.0	6 x 16
1500488	H27328	T60	100.0	6 x 16

S-2 High quality alloy steel, Integral quenching, Uneasy to break and slip

12.5MM DR. SPLINE BIT SOCKET

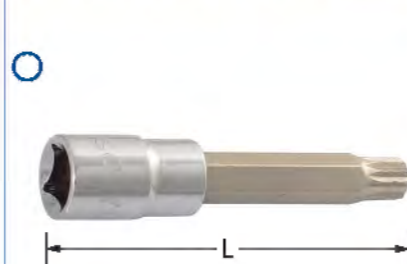

EBS No.	Item No.	SIZE	L(MM)	pcs-case
1500521	H27727	M10	120	4 x 20
1500522	H27728	M12	140	4 x 20

Used for repairing automobile
S-2 High quality alloy steel, Integral quenching, Uneasy to break and slip

12.5MM DR. HEX BIT SOCKET

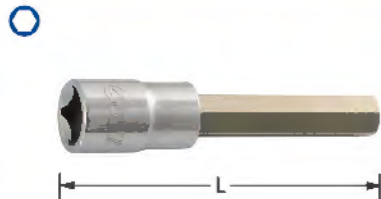

EBS No.	Item No.	SIZE	L(MM)	pcs-case
1502030	H27430	6MM	70MM	6 x 16
1502031	H27431	8MM	120MM	6 x 16
1502032	H27432	6MM	140MM	6 x 16
1502033	H27433	10MM	140MM	6 x 16
1502034	H27434	5MM	180MM	6 x 16
1502035	H27435	6MM	250MM	6 x 16

S-2 High quality alloy steel, Integral quenching, Uneasy to break and slip

12.5MM DR. HEX BIT SOCKET



EBS No.	Item No.	SIZE	L(MM)	pcs-case
1500489	H27410	4.0mm	50.0	6 x 24
1500490	H27411	5.0mm	50.0	6 x 24
1500491	H27412	6.0mm	50.0	6 x 24
1500492	H27413	7.0mm	50.0	6 x 24
1500493	H27414	8.0mm	50.0	6 x 24
1500494	H27415	10.0mm	50.0	6 x 24
1500495	H27416	12.0mm	50.0	6 x 24
1500496	H27417	14.0mm	50.0	6 x 24
1500497	H27418	17.0mm	50.0	6 x 24

S-2 High quality alloy steel, Integral quenching, Uneasy to break and slip

12.5MM DR. 100L HEX BIT SOCKET



EBS No.	Item No.	SIZE	L(MM)	pcs-case
1500498	H27420	4.0mm	100.0	6 x 16
1500499	H27421	5.0mm	100.0	6 x 16
1500500	H27422	6.0mm	100.0	6 x 16
1500501	H27423	7.0mm	100.0	6 x 16
1500502	H27424	8.0mm	100.0	6 x 16
1500503	H27425	10.0mm	100.0	6 x 16
1500504	H27426	12.0mm	100.0	6 x 16
1500505	H27427	14.0mm	100.0	6 x 16
1500506	H27428	17.0mm	100.0	6 x 16

S-2 High quality alloy steel, Integral quenching, Uneasy to break and slip



H02323 1501550
7Pc Ratcheting Stubby Combination Wrench Set-Full Polish, Metric (12set/ctn)



- 7Pc Ratcheting Stubby Combination Wrench (10,11,12,13,14,15,17,19MM)
- Shorten and thicken design for narrow space

H02301 1500027
11PC. COMBINATION WRENCH SET (METRIC) (8set/ctn)



DESCRIPTION:
8,9,10,11,12,13,14,15,17,19,22MM

H02315 1501421
6Pc Double End Ratcheting Box Wrench Set-Full Polish, Metric (12set/ctn)



- 6Pc Double End Ratcheting Box Wrench Set (8*9,10*11,12*13,14*15,16*18,17*19MM)*

H02324 1501551
6Pc Combination Open & Socket End Wrench-Full Polish, Metric (6set/ctn)



- 6Pc Combination Open & Socket End Wrench (10,12,13,14,17,19MM)*

H02305 1500031
12PC. DOUBLE RATCHETING COMBINATION WRENCH SET (METRIC) (8set/ctn)



- DESCRIPTION:
8,9,10,11,12,13,14,15,16,17,18,19MM

H02316 1501422
8Pc Reversible Ratcheting Wrench Set-Full Polish, Metric (12set/ctn)



- 8Pc Reversible Ratcheting Wrench Set-Full Polish, Metric (8,10,12,13,14,15,17,19MM)

H02300 1500026
9PC. COMBINATION WRENCH SET (METRIC) (12set/ctn)



DESCRIPTION:
8,10,11,12,13,14,15,17,19MM

H02312 1501420
8Pc Ratcheting Combination Wrench Set-Full Polish, Metric (12set/ctn)



- 8Pc Ratcheting Combination Wrench Set-Full Polish, Metric (8,10,12,13,14,15,17,19MM)

H02317 1501423
7Pc Flexible Ratcheting Combination Wrench Set-Full Polish, Metric (12set/ctn)



- 7Pc Flexible Ratcheting Combination Wrench Set (10,12,13,14,15,17,19MM)*

H02308 1500034
3Pc Adjustable Wrench Set (12set/ctn)



- 6" Adjustable Wrench
- 8" Adjustable Wrench
- 10" Adjustable Wrench

H02306 1500032
6PC. DOUBLE OPEN END WRENCH SET (METRIC) (12set/ctn)



DESCRIPTION:
6x7,8x10,11x13,12x14,17x19,21x23MM

H02303 1500029
11PC. DOUBLE BOX END WRENCH SET (METRIC) (4set/ctn)



DESCRIPTION:
8x10,10x12,11c13,12x14,14x17,17x19,19x21,21x23,22x24,23x26,24x27MM

H02326 1501552
4Pc Star Wrench Set-Full Polish, Metric (46set/ctn)



- 4Pc Star Wrench Set-Full Polish, Metric (E6*E8,E10*E12,E14*E18,E20*E24)

H02302 1500028
14PC. COMBINATION WRENCH SET (METRIC) (6set/ctn)



DESCRIPTION:
8,9,10,11,12,13,14,15,16,17,18,19,22,24MM

H02307 1500033
6PC. DOUBLE BOX END WRENCH SET (METRIC) (12set/ctn)



DESCRIPTION:
8x10,11x13,12x14,17x19,21x23,22x24MM

H02327 1501553
3Pc Flare Nut Wrench Set-Full Polish, Metric (46set/ctn)



- 3Pc Flare Nut Wrench Set-Full Polish, Metric (9*11,13*14,16*17MM)

H02304 1500030
13PC. DOUBLE OPEN END WRENCH SET (METRIC) (4set/ctn)



DESCRIPTION:
6x7,8x10,10x12,11x13,12x14,14x17,17x19,19x21,21x23,22x24,23x26,24x27,30x32MM



H02309 1501383
23Pc Combination Wrench Set-Full Polish, Metric (2set/ctn)



• 23-Combination Wrench Set-Full Polish, Metric
(6,7,8,9,10,11,12,13,14,15,16,17,18,19,20,21,22,23,24,25,27,30,32MM)

H02310 1501546
10Pc Double Open End Wrench Set-Full Polish, Metric (2set/ctn)



• 10Pc Double Open End Wrench Set-Full Polish, Metric
(5.5*7,8*10,9*11,10*12,12*14,14*17,17*19,19*22,24*27,30*32MM)

H02311 1501547
10Pc Double Box End Wrench Set-Full Polish, Metric (2set/ctn)



• 10Pc Double Box End Wrench Set-Full Polish, Metric
(5.5*7,8*10,9*11,10*12,12*14,14*17,17*19,19*22,24*27,30*32MM)

H02313 1501548
8Pc Double Open End Wrench Set-Full Polish, Metric (12set/ctn)



• 8Pc Double Open End Wrench Set-Full Polish, Metric
(5.5*7,8*10,9*11,12*14,14*17,17*19,19*22,24*27MM)

H02321 1501549
8Pc Double Box End Wrench Set-Full Polish, Metric (2set/ctn)



• 8Pc Double Box End Wrench Set-Full Polish, Metric
(5.5*7,8*10,9*11,12*14,14*17,17*19,19*22,24*27MM)

VDE Insulated Adjustable Wrench



EBS No.	Item No.	SIZE(MM)	pcs. case
1501964	H15132	8"	6 x 2
1501965	H15133	10"	4 x 8

- Imported two color material handle, elegant appearance, oil resistance and prevent scratch
- Made of alloy steel, chrome finish, better rusting
- 1000V high voltage testing, ensure user safety

Adjustable Wrench, Chrome Plain



EBS No.	Item No.	SIZE(MM)	Max	pcs. case
1501954	H15100	4"	15mm	6 x 20
1500132	H15101	6"	20mm	6 x 15
1500133	H15102	8"	25mm	6 x 8
1500134	H15103	10"	30mm	6 x 6
1500135	H15104	12"	35mm	4 x 8
1500136	H15105	15"	45mm	3 x 8
1501955	H15106	18"	55mm	- x 1
1501956	H15107	24"	67mm	- x 1

- Made of Imported Cr-V
- Heat treatment, full polish

Adjustable Wrench-4", Cusion Grip



EBS No.	Item No.	SIZE(MM)	Max	pcs. case
1501957	H15110	4"	12.8mm	8 x 30
1501958	H15111	6"	19.2mm	8 x 18
1501959	H15112	8"	24.1mm	6 x 12
1501960	H15113	10"	28.8mm	6 x 8
1501961	H15114	12"	33.6mm	4 x 6
1501962	H15115	15"	43.3mm	2 x 6
1501963	H15116	18"	52.4mm	2 x 4
1501347	H15117	24"	62.0mm	- x 1

- High Quality Carbon Steel
- Pearl nickel finish, resistance for corrosion
- Cusion Grip Handle
- Laser measurements, Direct observation size
- Numerical control machine tool, smoothly operation
- Heat treatment head, durable for impact, long lifetime

COMBINATION WRENCH (METRIC)



EBS No.	Item No.	SIZE(MM)	L(mm)	D1	D2	pcs. case
1500058	H11200	5.5	123.0	10.0	14.7	6 x 50
1500059	H11201	6	123.0	10.0	14.7	6 x 50
1500060	H11202	7	128.0	11.2	15.7	6 x 50
1500061	H11203	8	135.0	12.4	17.9	8 x 50
1500062	H11204	9	142.0	14.4	20.2	6 x 20
1500063	H11205	10	149.0	16.6	22.6	6 x 20
1500064	H11206	11	167.0	16.7	23.9	6 x 20
1500065	H11207	12	173.0	18.6	25.9	6 x 20
1500066	H11208	13	179.0	19.4	26.2	6 x 15
1500067	H11209	14	192.0	21.9	30.2	6 x 15
1500068	H11210	15	199.0	22.4	32.1	6 x 15
1500069	H11211	16	206.0	23.8	33.4	6 x 15
1500070	H11212	17	227.0	26.1	36.6	6 x 8
1500071	H11213	18	238.0	27.1	38.5	6 x 8
1500072	H11214	19	249.0	28.2	40.1	6 x 8
1501244	H11215	20	264.7	29.7	41.8	4 x 6
1500073	H11216	21	270.0	30.2	42.9	4 x 8
1500074	H11217	22	294.0	32.1	45.2	4 x 6
1501245	H11218	23	303.6	33.2	48.0	4 x 6
1500075	H11219	24	316.0	34.0	51.4	4 x 6
1501246	H11220	25	334.1	35.9	52.2	4 x 8
1500076	H11221	27	359.0	40.4	57.9	4 x 8
1500077	H11222	30	391.0	41.8	61.4	2 x 6
1500078	H11223	32	426.0	45.0	65.4	2 x 6
1501891	H11225	34	470.0	40.0	65.0	2 x 6
1501892	H11226	35	466.0	42.0	67.0	2 x 6
1501893	H11227	36	510.0	45.0	69.0	2 x 6
1501894	H11228	38	510.0	49.0	72.0	2 x 6
1501895	H11229	41	550.0	53.0	77.0	2 x 6
1501896	H11230	42	550.0	55.0	78.0	2 x 6
1501897	H11231	46	612.0	62.0	86.0	2 x 6
1501899	H11233	50	650.0	72.0	97.0	1 x 1
1501900	H11234	55	665.0	78.0	113.0	1 x 1
1501901	H11235	60	760.0	86.0	122.0	1 x 1

Combination Wrench, Full Polish, Metric



EBS No.	Item No.	SIZE(MM)	L(mm)	D1	D2	pcs. case
1501902	H11405	10	94.0	15.3	20.8	6 x 36
1501903	H11406	11	102.0	17.6	22.9	6 x 36
1501904	H11407	12	105.0	18.8	25.0	6 x 36
1501905	H11408	13	107.0	20.1	27.1	6 x 36
1501906	H11409	14	114.0	21.5	29.2	6 x 18
1501907	H11412	17	126.0	26.7	35.5	6 x 18
1501908	H11414	19	138.0	28.4	39.7	6 x 18

- Made of Imported Cr-V
- Heat treatment, full polish

Combination Wrench, Full Polish, Dr.SAE



EBS No.	Item No.	SIZE	L(mm)	D1	D2	pcs. case
1501873	H11100	1/4"	125.9	10.7	13.5	6 x 50
1501874	H11101	5/16"	138.6	13.8	16.7	6 x 50
1501875	H11102	3/8"	151.3	15.3	20.8	6 x 20
1501876	H11103	7/16"	165.3	17.6	22.9	6 x 20
1501877	H11104	1/2"	178.2	20.1	27.1	6 x 15
1501878	H11105	9/16"	190.9	21.5	29.2	6 x 15
1501879	H11106	5/8"	208.6	24.4	33.4	6 x 15
1501880	H11107	11/16"	225.8	26.7	35.5	6 x 8
1501881	H11108	3/4"	248.0	28.4	39.7	6 x 8
1501882	H11109	13/16"	270.3	30.6	43.8	4 x 8
1501883	H11110	7/8"	292.5	32.3	45.9	4 x 6
1501884	H11111	15/16"	314.7	34.1	50.1	4 x 6
1501885	H11112	1"	334.1	35.9	52.2	4 x 8
1501886	H11113	1-1/16"	359.2	38.8	56.4	4 x 8
1501887	H11114	1-1/8"	402.5	42.8	62.6	3 x 6
1501888	H11115	1-1/4"	430.2	45.9	65.6	2 x 6
1501889	H11116	1-1/2"	499.6	50.8	76.2	2 x 6

DOUBLE OPEN END WRENCH (METRIC)

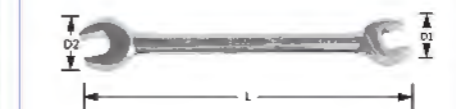

EBS No.	Item No.	SIZE(MM)	L(mm)	D1	D2	pcs. case
1501247	H12200	5.5x7	122	13.0	15.0	6 x 20
1500079	H12201	6x7	123	13.9	15.9	6 x 50
1500080	H12202	8x10	134	16.9	19.4	6 x 20
1501248	H12203	9x11	149	19.0	22.0	6 x 20
1500081	H12204	10x12	149	19.4	23.4	6 x 20
1500082	H12205	11x13	158	23.4	26.2	6 x 20
1500083	H12206	12x14	168	25.9	28.8	6 x 15
1501920	H12207	13x15	182	27.1	33.4	6 x 15
1500084	H12209	14x17	191	29.9	35.9	6 x 15
1501922	H12210	16x18	227	35.5	39.7	6 x 8
1500085	H12211	17x19	227	36.9	38.9	6 x 8
1500086	H12212	19x21	239	36.9	42.4	4 x 8
1501249	H12213	19x22	254	39.0	42.0	4 x 8
1500087	H12214	21x23	254	41.9	44.9	4 x 8
1500088	H12215	22x24	266	44.9	48.9	4 x 6
1500089	H12216	23x26	279	48.9	51.4	4 x 6
1500090	H12217	24x27	279	48.9	51.4	4 x 6
1501923	H12218	27x30	290	56.4	52.2	4 x 6
1500091	H12219	30x32	288	59.4	64.4	4 x 6

- Made of Imported Cr-V
- Heat treatment, full polish

Double Open End Wrench, Full Polish, Dr. SAE



EBS No.	Item No.	SIZE	L(mm)	D1	D2	pcs. case
1501909	H12100	1/4"x5/16"	123.5	12.5	16.7	6 x 50
1501910	H12101	3/8"x7/16"	149.2	20.8	22.9	6 x 20
1501911	H12102	1/2"x9/16"	175.0	27.1	29.2	6 x 15
1501912	H12103	5/8"x11/16"	200.7	33.4	35.5	6 x 15
1501913	H12104	11/16"x3/4"	226.5	35.5	39.7	6 x 8
1501914	H12105	13/16"x7/8"	226.5	35.5	39.7	4 x 8
1501915	H12106	15/16"x1"	278.2	50.1	52.2	4 x 6
1501916	H12107	1-1/8"x1-1/4"	308.4	62.6	66.8	4 x 6

- Made of Imported Cr-V
- Heat treatment, full polish

DOUBLE BOX END WRENCH (METRIC)



EBS No.	Item No.	SIZE(MM)	L(mm)	D1	D2	pcs. case
1501250	H13200	5.5X7	165.0	11.3	13.6	6 x 32
1501932	H13201	6X7	165.0	11.3	13.6	6 x 32
1500092	H13202	8X10	169.0	14.1	16.1	6 x 32
1501251	H13203	9X11	195.0	16.2	18.4	6 x 32
1500093	H13204	10X12	194.0	16.8	18.8	6 x 32
1500094	H13205	11X13	205.0	19.6	21.6	6 x 32
1500095	H13206	12X14	205.0	19.6	21.6	6 x 32
1501933	H13207	13X15	236.0	22.7	24.8	6 x 32
1500096	H13209	14X17	236.0	23.6	25.6	

DOUBLE RATCHETING COMBINATION WRENCH (METRIC)



EBS No.	Item No.	SIZE	L(mm)	A(mm)	pcs/case
1500104	H14101	6mm	135.0	17.1	6 x 50
1500105	H14102	7mm	135.0	17.1	6 x 50
1500106	H14103	8mm	135.0	17.1	6 x 50
1500107	H14104	9mm	142.0	18.9	6 x 20
1500108	H14105	10mm	159.0	20.6	6 x 20
1500109	H14106	11mm	167.0	22.3	6 x 20
1500110	H14107	12mm	173.0	23.6	6 x 15
1500111	H14108	13mm	179.0	25.6	6 x 15
1500112	H14109	14mm	192.0	27.3	6 x 15
1500113	H14110	15mm	199.0	28.6	6 x 15
1500114	H14111	16mm	215.0	30.3	6 x 6
1500115	H14112	17mm	232.0	32.6	6 x 6
1500116	H14113	18mm	238.0	33.3	6 x 6
1500117	H14114	19mm	249.0	34.4	6 x 6
1500118	H14115	21mm	284.0	41.6	4 x 6
1500119	H14116	22mm	284.0	41.6	4 x 6
1500120	H14117	24mm	324.0	47.1	4 x 8
1500121	H14119	27mm	358.0	51.6	4 x 8
1500122	H14120	30mm	424.0	59.6	2 x 6
1500123	H14121	32mm	424.0	59.6	2 x 6

- Made of Imported Cr-V
- Heat treatment, full polish

10MM Bit Holder for 10MM Ratcheting Wrench



EBS No.	Item No.	SIZE	L(MM)	pcs/case
1501387	H15704	1/4"	10.0	24 x 24

Adaptor for Ratcheting Wrench



EBS No.	Item No.	SIZE	L(mm)	pcs/case
1501384	H15701	1/4"	10.0	24 x 24
1501385	H15702	3/8"	13.0	24 x 24
1501386	H15703	1/2"	19.0	8 x 48

DOUBLE BOX RATCHETING WRENCH (METRIC)



EBS No.	Item No.	SIZE	L(mm)	D1	D2	pcs/case
1501951	H14500	8x9mm	130.0	16.5	17.0	6 x 20
1500125	H14501	8x10mm	127.0	17.1	20.6	6 x 20
1500126	H14502	10x11mm	149.0	20.6	22.3	6 x 20
1500127	H14503	12x13mm	169.0	23.6	25.6	6 x 15
1500128	H14504	14x15mm	189.0	27.3	30.3	6 x 15
1500129	H14505	16x18mm	229.0	32.2	34.4	6 x 6
1500130	H14500	17x19mm	229.0	32.2	34.4	6 x 6
1500131	H14507	22x24mm	289.0	41.6	47.1	6 x 8

- Made of Imported Cr-V
- Heat treatment, full polish

Combination Wrench, Matte Finish



EBS No.	Item No.	SIZE	L(mm)	D1	D2	pcs/case
1503655	H11245	34mm	476.0	50.0	71.0	6x2
1503656	H11246	35mm	476.0	50.0	71.0	6x2
1503657	H11247	36mm	501.0	55.5	79.0	6x2
1503658	H11248	38mm	501.0	55.5	79.0	6x2
1503659	H11249	41mm	578.0	61.0	86.5	6x2
1503660	H11250	42mm	578.0	61.0	86.5	6x2
1503661	H11251	46mm	615.0	65.5	93.0	6x1
1503662	H11252	48mm	654.0	74.4	100.0	6x1
1503663	H11253	50mm	654.0	74.4	100.0	6x1
1503664	H11254	55mm	670.0	80.0	109.0	6x1
1503665	H11255	60mm	692.0	87.0	120.0	6x1

Combination short Wrench, Full Polish, Metric



EBS No.	Item No.	SIZE	L(mm)	A(mm)	pcs/case
1501941	H14303	10MM	94.0	18.5	6 x 36
1501943	H14305	12MM	105.0	21.5	6 x 36
1501944	H14306	13MM	107.0	23.0	6 x 36
1501945	H14307	14MM	114.0	25.3	6 x 18
1501946	H14308	15MM	118.0	26.7	6 x 18
1501948	H14310	17MM	126.0	30.5	6 x 18
1501950	H14312	19MM	138.0	32.5	6 x 18

- Made of Imported Cr-V
- Heat treatment, full polish

Reversible Ratcheting Combination Wrench, Full Polish, Metric



EBS No.	Item No.	SIZE	L(mm)	A(mm)	pcs/case
1501262	H14701	8MM	139.9	15.8	6 x 20
1501263	H14702	9MM	149.4	17.5	6 x 20
1501264	H14703	10MM	158.9	19.0	6 x 20
1501265	H14704	11MM	165.3	20.5	6 x 20
1501266	H14705	12MM	171.6	21.7	6 x 15
1501267	H14706	13MM	178.0	23.6	6 x 15
1501268	H14707	14MM	190.6	25.9	6 x 15
1501269	H14708	15MM	199.5	27.1	6 x 15
1501270	H14709	16MM	208.3	28.7	6 x 6
1501271	H14710	17MM	225.5	30.5	6 x 6
1501272	H14711	18MM	236.6	31.4	6 x 6
1501273	H14712	19MM	248.0	32.4	6 x 6
1501274	H14713	20MM	291.5	39.0	4 x 6
1501275	H14714	21MM	291.5	39.0	4 x 6
1501276	H14715	22MM	333.1	39.0	4 x 6
1501277	H14716	24MM	333.1	45.5	4 x 8

- Made of Imported Cr-V
- Heat treatment, full polish

Flexible Ratcheting Combination Wrench-Full Polish, Full Polish, Metric

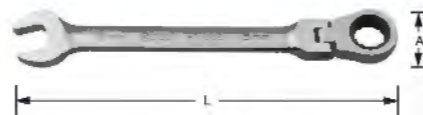

EBS No.	Item No.	SIZE	L(mm)	A(mm)	pcs/case
1501278	H14901	8MM	140.0	16.0	6 x 20
1501279	H14902	9MM	149.0	17.5	6 x 20
1501280	H14903	10MM	158.0	19.0	6 x 20
1501281	H14904	11MM	165.0	20.5	6 x 20
1501282	H14905	12MM	171.0	21.7	6 x 15
1501283	H14906	13MM	178.0	23.6	6 x 15
1501284	H14907	14MM	190.0	25.9	6 x 15
1501285	H14908	15MM	199.0	26.7	6 x 15
1501286	H14909	16MM	208.0	28.4	6 x 15
1501287	H14910	17MM	225.0	30.5	6 x 8
1501288	H14911	18MM	236.0	31.5	6 x 8
1501289	H14912	19MM	248.0	32.5	6 x 6
1501290	H14913	20MM	291.0	40.0	4 x 6
1501291	H14914	21MM	291.0	40.0	4 x 6
1501292	H14915	22MM	291.0	40.0	4 x 6
1501293	H14916	24MM	333.0	45.5	4 x 8

- Made of Imported Cr-V
- Heat treatment, full polish
- 180° rotation head, especially used in narrow space
- High quality with thickened delicate design, full polish surface

Flare Nut Wrench-8MMX10MM, Full Polish, Metric



EBS No.	Item No.	SIZE(MM)	L(MM)	D1	D2	pcs/case
1501253	H13401	8x10	152.0	19.4	22.1	6 x 20
1501254	H13402	9x11	152.0	19.4	22.1	6 x 20
1501255	H13403	13x14	178.7	24.9	26.1	6 x 15
1501256	H13404	16x17	210.5	29.0	32.0	6 x 15
1501257	H13405	10x12	166.0	21.0	23.4	6 x 20

- Made of Imported Cr-V
- Heat treatment, full polish

Slugging Box End Wrench



EBS No.	Item No.	SIZE(MM)	A(mm)	L(mm)	pcs/case
1501967	H15401	27	27.0	175.0	6 x 4
1501968	H15402	30	30.0	185.0	6 x 4
1501969	H15403	32	32.0	185.0	6 x 4
1501970	H15404	36	36.0	205.0	6 x 4
1501971	H15405	41	41.0	225.0	6 x 4
1501972	H15406	46	46.0	235.0	6 x 4
1501973	H15407	50	50.0	250.0	6 x 3
1501974	H15408	55	55.0	265.0	6 x 2
1501975	H15409	60	60.0	274.0	6 x 2
1501976	H15410	65	65.0	298.0	6 x 2
1501977	H15411	70	70.0	320.0	3 x 2

- DIN 133 Standard
- Made of 40Cr-V
- Uniform HRC with Heat treatment
- Corrosion Resistance, durable for impact, beautiful appearance

Slugging Open End Wrench



EBS No.	Item No.	SIZE	S(mm)	L(mm)	pcs/case
1501978	H15451	27mm	27.0	175.0	6 x 4
1501979	H15452	30mm	30.0	190.0	6 x 4
1501980	H15453	32mm	32.0	190.0	6 x 4
1501981	H15454	36mm	36.0	210.0	6 x 4
1501982	H15455	41mm	41.0	230.0	6 x 4
1501983	H15456	46mm	46.0	250.0	6 x 3
1501984	H15457	50mm	50.0	275.0	6 x 2
1501985	H15458	55mm	55.0	305.0	6 x 2
1501986	H15459	60mm	60.0	315.0	3 x 2
1501987	H15460	65mm	65.0	335.0	3 x 2
1501988	H15461	70mm	70.0	370.0	3 x 2

- DIN 133 Standard
- Made of 40Cr-V
- Uniform HRC with Heat treatment
- Corrosion Resistance, durable for impact, beautiful appearance

Star Wrench-, Full Polish, Metric



EBS No.	Item No.	SIZE(MM)	D1	D2	pcs/case
1501258	H13501	E6xE8	4.8MM	4.8MM	6 x 50
1501259	H13502	E10xE12	6.8MM	6.8MM	6 x 50
1501260	H13503	E14xE18	7.9MM	7.9MM	6 x 20
1501261	H13504	E20xE24	11.0MM	13.0MM	4 x 15

- Made of Imported Cr-V
- Heat treatment, full polish

Dual Socket Spud Ratcheting Wrench



EBS No.	Item No.	SIZE	L(mm)	A(mm)	pcs/case
1501966	H15305	12x14mm	235.0	32.0	2 x 15
1501348	H15308	14x17mm	270.0	35.0	2 x 8
1501349	H15305	17x19mm	312.0	42.0	2 x 15
1501350	H15310	17x21mm	312.0	42.0	2 x 15
1501351	H15312	19x21mm	312.0	42.0	2 x 15
1501352	H15313	19x22mm	315.0	42.0	2 x 15
1501353	H15314	19x24mm	315.0	42.0	2 x 15
1501354	H15317	21x26mm	355.0	51.0	2 x 8
1501356	H15319	22x24mm	355.0	51.0	2 x 8
1501360	H15321	24x27mm	362.0	53.0	2 x 6
1501361	H15322	24x30mm	400.0	60.0	2 x 6
1501362	H15324	30x32mm	403.0	60.0	2 x 6
1501363	H15325	32x36mm	416.0	60.0	2 x 6

T - shaped inner and outer hexagon sleeve



EBS No.	Item No.	SIZE	L(mm)	pcs/case
1508466	H15513	8mm	314.0	12x4
1508467	H15514	9mm	314.0	12x4
1508468	H15515	10mm	314.0	12x4
1508469	H15516	11mm	314.0	12x4
1508470	H15517	12mm	314.0	12x4
1508471	H15518	13mm	314.0	6 x 4
1508472	H15519	14mm	314.0	6 x 4
1508473	H15520	17mm	314.0	6 x 4
1508474	H15521	19mm	314.0	



Dr. Professional Adjustable Torque Wrench



EBS NO.	Item NO.	Dr.	Torque Range	Accuracy	L(mm)	N.W.(Kg)	pcsxcase
1501652	H05121	1/4"	1-5Nm	0.05Nm	200	0.36	1x1
1501653	H05131	3/8"	6-30Nm	0.2Nm	257	0.44	1x1
1501654	H05141	1/2"	20-110Nm	0.5Nm	436	1.12	1x1
1501655	H05142	1/2"	40-210Nm	1Nm	497	1.47	1x1
1501656	H05143	1/2"	70-350Nm	1Nm	560	1.62	1x1
1501657	H05161	3/4"	75-450Nm	2.5Nm	815	3.30	1x1
1501658	H05162	3/4"	100-800Nm	5Nm	1000	7.08	1x1
1501659	H05163	3/4"	300-1500Nm	10Nm	1740	11.8	1x1

Industrial Use
 Accuracy: Clockwise: ±4%, Counterclockwise: ±6%
 Simply Designing for easy operating
 Many Sizes of torque wrenches for choice
 Type of Torque Setup: Adjustable torque wrench allows to pre-setup the torque and direction before applied on the work piece (Clockwise or anticlockwise)

Dr. Professional Adjustable Torque Wrench



EBS NO.	Item NO.	Dr.	Torque Range	Accuracy	L(mm)	N.W.(Kg)	pcsxcase
1501664	H05331	3/8"	10-60Nm	0.25Nm	427	1.15	1x1
1501665	H05341	1/2"	20-100Nm	0.5Nm	462	1.50	1x1
1501666	H05342	1/2"	40-200Nm	1Nm	517	2.20	1x1
1501667	H05343	1/2"	60-320Nm	2Nm	586	2.30	1x1
1501668	H05361	3/4"	100-500Nm	4Nm	820	3.65	1x1
1501669	H05362	3/4"	100-800Nm	5Nm	1111	5.48	1x1

Industrial Use
 Accuracy: Clockwise: ±4%, Counterclockwise: ±6%
 Simply Designing for easy operating
 Many Sizes of torque wrenches for choice
 Type of Torque Setup: Adjustable torque wrench allows to pre-setup the torque and direction before applied on the work piece (Clockwise or anticlockwise)

Imported From Taiwan

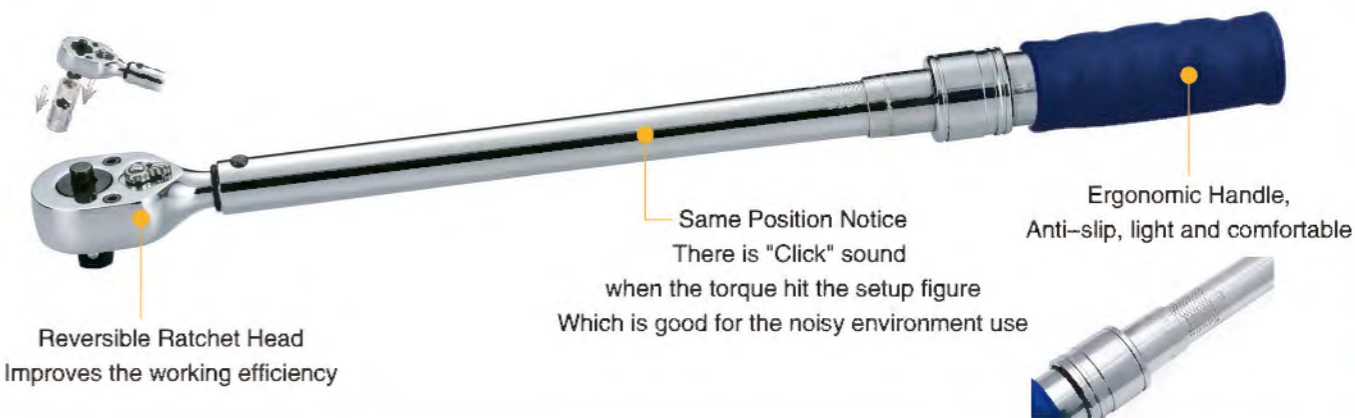

Professional Interchangeable Head Torque Wrench



EBS NO.	Item NO.	Torque Range	Accuracy	L(mm)	N.W.(Kg)	pcsxcase
1501671	H05431	10-60Nm	0.25Nm	424	0.90	1x1
1501672	H05441	20-100Nm	0.5Nm	459	1.40	1x1
1501673	H05442	40-200Nm	1Nm	483	2.10	1x1
1501674	H05443	60-320Nm	2Nm	552	2.20	1x1
1501676	H05461	100-500Nm	4Nm	794	3.50	1x1

Orque Wrench Head, Round Ratchet



EBS NO.	Item NO.	Dr.	Teeth	W	H	L	L1	L2	N.W.	pcsxcase
		(Inch)		(mm)	(mm)	(mm)	(mm)	(mm)	(kg)	
1501687	H05601	3/8"	72	35.5	36.0	62.5	20.2	15.0	0.196	4x4
1501688	H05602	1/2"	72	43.0	44.5	71.0	24.7	15.0	0.306	4x4

Easy changing, especially for the tighten in the tight sapce
Heat treated reinforce the strength
Locking pin prevents falling apart

Torque Multiplier

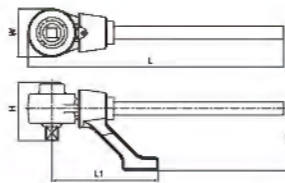

EBS NO.	Item NO.	Max Input(Nm)	Max Output(Nm)	Scale	Input Dr.	Output Dr.	W (mm)	H (mm)	H1 (mm)	L (mm)	L1 (mm)	N.W. (kg)	pcsxcase
1501678	H05501	500	1500	1:3	1/2"	3/4"	73	84	90	420	157	3.09	1x1
1501679	H05502	1000	3000	1:3	3/4"	1"	92	104	120	500	206	6.49	1x1



Open End Torque Wrench Head



EBS NO.	Item NO.	B (mm)	W(mm)	H (mm)	L (mm)	L1(mm)	L2(mm)	N.W. (kg)	pcsxcase
1501690	H05611	7	24.0	5.0	36.9	17.5	11.5	0.038	12x10
1501691	H05612	8	24.0	5.0	37.3	17.5	11.5	0.038	12x10
1501692	H05613	9	24.0	5.5	37.7	17.5	11.5	0.039	12x10
1501693	H05614	10	30.0	5.5	38.6	17.5	11.5	0.042	12x10
1501694	H05615	11	30.0	5.5	38.6	17.5	11.5	0.043	12x10
1501695	H05616	12	30.0	7.0	39.0	17.5	11.5	0.048	12x10
1501696	H05617	13	30.0	7.0	41.9	20.0	11.5	0.052	12x10
1501697	H05618	14	35.0	8.0	42.3	20.0	11.5	0.059	12x10
1501698	H05619	15	35.0	8.0	42.7	20.0	11.5	0.059	12x10
1501699	H05620	16	38.0	8.5	43.2	20.0	11.5	0.067	12x10
1501700	H05621	17	38.0	8.5	43.6	20.0	11.5	0.067	12x10
1501701	H05622	18	42.0	9.0	46.0	22.0	11.5	0.075	12x10
1501702	H05623	19	42.0	9.0	46.4	22.0	11.5	0.075	12x10
1501710	H05632	22	53.0	11.0	66.7	32.0	15.0	0.015	6x10
1501711	H05633	24	53.0	11.0	67.5	32.0	15.0	0.015	6x10
1501712	H05634	27	60.0	13.0	70.8	34.0	15.0	0.015	6x10
1501713	H05635	30	66.0	14.0	74.1	36.0	15.0	0.015	3x4
1501714	H05636	32	66.0	14.0	76.4	37.5	15.0	0.015	3x4
1501715	H05637	34	73.0	14.0	82.4	42.0	15.0	0.015	3x4
1501716	H05638	36	73.0	14.0	82.4	42.0	15.0	0.015	3x4
1501717	H05639	41	82.0	14.0	83.4	42.0	15.0	0.015	2x4
1501718	H05640	46	91.0	14.0	86.4	43.0	15.0	0.015	2x4

Box End Torque Wrench Head

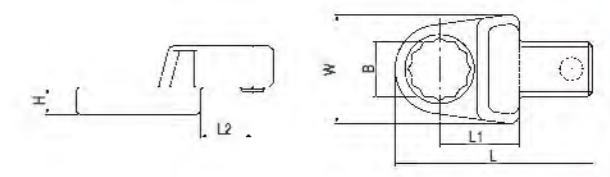

EBS NO.	Item NO.	B (mm)	W(mm)	H (mm)	L (mm)	L1(mm)	L2(mm)	N.W. (kg)	pcsxcase
1501719	H05641	7	24.9	5.0	42.4	17.5	11.5	0.042	12x10
1501720	H05642	8	24.9	5.0	42.4	17.5	11.5	0.042	12x10
1501721	H05643	9	24.9	5.5	43.9	17.5	11.5	0.042	12x10
1501722	H05644	10	26.5	5.5	45.1	17.5	11.5	0.052	12x10
1501723	H05645	11	26.5	6.0	45.2	17.5	11.5	0.050	12x10
1501724	H05646	12	26.7	6.0	45.5	17.5	11.5	0.048	12x10
1501725	H05647	13	27.2	7.0	49.0	20.0	11.5	0.060	12x10
1501726	H05648	14	27.0	7.0	50.0	20.0	11.5	0.064	12x10
1501727	H05649	15	27.0	8.0	50.2	20.0	11.5	0.064	9x10
1501728	H05650	16	27.0	8.0	50.3	20.0	11.5	0.062	9x10
1501729	H05651	17	28.6	9.0	53.9	22.0	11.5	0.074	9x10
1501730	H05652	18	28.6	9.0	53.9	22.0	11.5	0.074	9x10
1501731	H05653	19	38.0	9.0	72.3	22.0	11.5	0.068	9x10
1501737	H05659	22	42.0	16.0	77.0	32.0	15.0	0.250	4x10
1501738	H05660	24	42.0	16.0	78.0	32.0	15.0	0.254	4x10
1501739	H05661	27	43.4	17.0	81.5	34.0	15.0	0.280	4x10
1501740	H05662	30	47.3	19.0	86.7	36.0	15.0	0.328	4x10
1501741	H05663	32	47.3	19.0	86.7	36.0	15.0	0.312	4x10
1501742	H05664	34	50.0	19.0	89.6	38.0	15.0	0.324	4x10
1501743	H05665	36	54.6	19.0	91.0	38.0	15.0	0.316	4x10
1501744	H05666	41	60.0	20.0	98.5	42.0	15.0	0.392	2x4
1501745	H05667	46	64.8	20.0	103.0	42.0	15.0	0.396	2x4



H02418 1501569
7Pc Long Hex Key Set (6setx12case)



- DESCRIPTION: 1.5,2,2.5,3,4,5,6MM
- S2 upgrade material, High torque
- Hex Easy to engage and fall off
- Full polish Cr finish

H02401 1500036
9PC. EXTRA LONG BALL END HEX KEY SET (METRIC) (6setx8case)



- DESCRIPTION: 1.5,2,2.5,3,4,5,6,8,10MM
- S2 upgrade material, High torque
- Hex Easy to engage and fall off
- Full polish Cr finish

H02400 1500035
10Pc Hex Key Set-Metric (10setx6case)



- 10Pc Hex Key Set(1.5,2,2.5,3,4,5,5.5,6,8,10MM)
- CR-V upgrade material, High torque
- Hex Easy to engage and fall off
- Full polish Cr finish

H02419 1501570
7Pc Long Ball End Hex Key Set (6setx12case)



- 7Pc Long Ball Hex Key Set(1.5,2,2.5,3,4,5,6MM)
- S2 upgrade material, High torque
- Hex Easy to engage and fall off
- Full polish Cr finish

H02403 1500037
9PC. EXTRA LONG HEX KEY SET (METRIC) (6setx8case)



- DESCRIPTION: 1.5,2,2.5,3,4,5,6,8,10MM
- S2 upgrade material, High torque
- Hex Easy to engage and fall off
- Full polish Cr finish

H02402 1501555
12Pc Extra L Arm Ball End Hex Key Set-SAE (6setx6case)



- 12Pc Extra L Arm Ball End Hex Key Set-SAE (1/16",5/64",3/32",7/64",1/8",9/64",5/32",3/16",7/32",1/4",5/16",3/8")
- S2 upgrade material, High torque
- Hex Easy to engage and fall off
- Full polish Cr finish

H02421 1501572
7PC. EXTRA LONG BALL END HEX KEY SET (METRIC) (6setx8case)



- DESCRIPTION: 1.5,2,2.5,3,4,5,6,MM
- S2 upgrade material, High torque
- Hex Easy to engage and fall off
- Full polish Cr finish

H02405 1500038
9PC. LONG BALL END HEX KEY SET (METRIC) (6setx8case)



- DESCRIPTION: 1.5,2,2.5,3,4,5,6,8,10MM
- S2 upgrade material, High torque
- Hex Easy to engage and fall off
- Full polish Cr finish

H02404 1501556
12Pc Extra Long Hex Key Set-SAE (6setx6case)



- 12Pc Extra L Arm Hex Key Set-SAE (1/16",5/64",3/32",7/64",1/8",9/64",5/32",3/16",7/32",1/4",5/16",3/8")
- S2 upgrade material, High torque
- Hex Easy to engage and fall off
- Full polish Cr finish

H02422 1501573
7PC. EXTRA LONG HEX KEY SET (METRIC) (6setx8case)



- DESCRIPTION: 1.5,2,2.5,3,4,5,6,MM
- S2 upgrade material, High torque
- Hex Easy to engage and fall off
- Full polish Cr finish

H02407 1500039
9PC. LONG ARM HEX KEY SET (METRIC) (6setx8case)



- DESCRIPTION: 1.5,2,2.5,3,4,5,6,8,10MM
- S2 upgrade material, High torque
- Hex Easy to engage and fall off
- Full polish Cr finish

H02406 1501557
12Pc Long Ball End Hex Key Set-SAE (6setx6case)



- 12Pc Long Ball End Hex Key Set-SAE (1/16",5/64",3/32",7/64",1/8",9/64",5/32",3/16",7/32",1/4",5/16",3/8")
- S2 upgrade material, High torque
- Hex Easy to engage and fall off
- Full polish Cr finish



H02408 1501558
12Pc Long Hex Key Set-**SAE** (6setx8case)



- 12Pc Long Hex Key Set-**SAE** (1/16", 5/64", 3/32", 7/64", 1/8", 9/64", 5/32", 3/16", 7/32", 1/4", 5/16", 3/8")
- S2 upgrade material, High torque
- Hex Easy to engage and fall off
- Full polish Cr finish

H02410 1501561
8Pc Long Security Star Key Set (6setx2case)

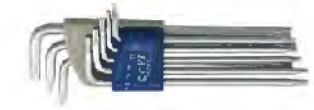

- 8pcs Long Security Star Key Set (TT6, TT7, TT8, TT9, TT10, TT15, TT20, TT25)
- S2 alloy steel, with security star, quench finish
- Matt finish, corrosion resistance, chrome plating

H02411 1501562
9Pc Long Security Star Key Set (6setx8case)

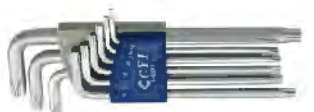

- 9pcs Long Security Star Key Set (TT10, TT15, TT20, TT25, TT27, TT30, TT40, TT45, TT50)
- S2 alloy steel, with security star, quench finish
- Matt finish, corrosion resistance, chrome plating

H02414 1501565
8Pc Mini Hex Key Set (24setx8case)



- 8Pc Mini Hex Key Set(0.7, 0.9, 1.3, 1.5, 2.2, 5.3, 4MM)
- Made of CR-V

H02415 1501566
8Pc Folding Hex Key Set (6setx4case)



- 8Pc Folding Hex Key Set (1.5, 2.2, 5.3, 4.5, 6.8)
- Made of Cr-V
- Ergonomic design handle, beautiful appearance and comfortable for using

H02416 1501567
9Pc Folding Hex Key Set-**SAE** (6setx4case)



- 9Pc Folding Hex Key Set-**SA** (1/4", 7/32", 3/16", 5/64", 3/32", 7/64", 1/8", 9/64", 5/32")
- Made of Cr-V
- Ergonomic design handle, beautiful appearance and comfortable for using

H02417 1501568
8Pc Folding Security Star Key Set (6setx4case)



- 8Pc Folding Security Star Key Set (TT9, TT10, TT15, TT20, TT25, TT27, TT30, TT40)
- Made of Cr-V
- Ergonomic design handle, beautiful appearance and comfortable for using

H02423 1501574
14Pc Long Ball End Hex Key Set (Metal Box) (6setx2case)



- Size: 1.5, 2.2, 5.3, 4.5, 5.5, 6.7, 8, 10, 12, 14, 7
- Widely used in Mechanical engineering industry, Mental box for easy take and store
- S2 upgrade material, 30% high torque than CRV material
- Full polish surface, corrosion resistance

H02424 1501575
14Pc Long Hex Key Set (Metal Box) (4setx2case)



- Size: 1.5, 2.2, 5.3, 4.5, 5.5, 6.7, 8, 10, 12, 14, 7
- Widely used in Mechanical engineering industry, Mental box for easy take and store
- S2 upgrade material, 30% high torque than CRV material
- Full polish surface, corrosion resistance

HEX KEY (METRIC)



EBS No.	Item No.	SIZE(MM)	L(mm)	A(mm)	pcs/case
1500927	H91300	1.5	45	14	72 x 12
1500928	H91301	2	50	16	72 x 12
1500929	H91302	2.5	56	18	72 x 6
1500936	H91303	3	63	20	36 x 12
1500931	H91305	4	70	25	36 x 12
1500932	H91306	5	80	28	36 x 4
1500933	H91308	6	90	32	36 x 4
1500934	H91310	8	100	36	18 x 4
1500935	H91311	10	112	40	18 x 4

- S2 Upgrade Material, high torsion, easy to insert

LONG HEX KEY (METRIC)



EBS No.	Item No.	SIZE(MM)	L(mm)	A(mm)	pcs/case
1500918	H91200	1.5	77	13.5	72 x 12
1500919	H91201	2	80	15.5	72 x 12
1500920	H91202	2.5	88.5	17.5	72 x 6
1500921	H91203	3	98.5	19	36 x 12
1500922	H91204	4	104	24	36 x 12
1500923	H91205	5	116	27	36 x 4
1500924	H91206	6	138	31	36 x 4
1500925	H91208	8	157.5	35	18 x 4
1500926	H91209	10	167	39	18 x 4
1502755	H91212	12	209	44	12 x 4
1502756	H91214	14	233	54.5	12 x 2
1502757	H91217	17	246	61.5	12 x 2

- S2 Upgrade Material, high torsion, easy to insert

EXTRA LONG SECURITY STAR KEY

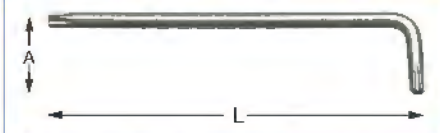

EBS No.	Item No.	SIZE(MM)	L(mm)	A(mm)	pcs/case
1502783	H93201	TT6	70	16	72 x 12
1502784	H93202	TT7	74	16	72 x 12
1502785	H93203	TT8	78	16	72 x 12
1502786	H93204	TT9	82	16	72 x 12
1502787	H93205	TT10	86	17	72 x 12
1502788	H93206	TT15	90	18	72 x 12
1502789	H93207	TT20	95	19	72 x 6
1502790	H93203	TT25	100	20	72 x 6
1502791	H93209	TT27	105	22	72 x 6
1502792	H93210	TT30	114	24	72 x 6
1502793	H93211	TT40	124	26	72 x 4
1502794	H93212	TT45	133	29	36 x 4
1502795	H93213	TT50	152	32	36 x 4
1502796	H93214	TT55	161	35	36 x 2
1502797	H93215	TT60	190	38	18 x 2

- S2 Upgrade Material, high torsion, easy to insert

EXTRA LONG HEX KEY (METRIC)



EBS No.	Item No.	SIZE(MM)	L(mm)	A(mm)	pcs/case
1500909	H91100	1.5	90	14	72 x 12
1500910	H91101	2	100	16	72 x 12
1500911	H91102	2.5	112	18	72 x 6
1500912	H91103	3	126	20	36 x 12
1500913	H91104	4	140	25	36 x 12
1500914	H91105	5	160	28	36 x 4
1500915	H91106	6	180	32	36 x 4
1500916	H91108	8	200	36	18 x 4
1500917	H91109	10	224	40	18 x 4

- S2 Upgrade Material, high torsion, easy to insert

LONG BALL END HEX KEY (METRIC)



EBS No.	Item No.	SIZE(MM)	L(mm)	A(mm)	pcs/case
1500945	H92200	1.5	90	14	72 x 12
1500946	H92201	2	100	16	72 x 12
1500947	H92202	2.5	112	18	72 x 6
1500948	H92203	3	126	20	36 x 12
1500949	H92204	4	140	25	36 x 12
1500950	H92205	5	160	28	36 x 4
1500951	H92207	6	180	32	36 x 4
1500952	H92209	8	200	36	18 x 4
1500953	H92210	10	224	40	18 x 4
1502780	H92212	12	250	45	12 x 4
1502781	H92214	14	280	55	12 x 2
1502782	H92217	17	320	60	12 x 2

- S2 Upgrade Material, high torsion, easy to insert

EXTRA LONG BALL END HEX KEY (METRIC)

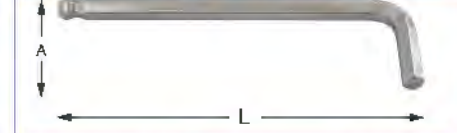

EBS No.	Item No.	SIZE(MM)	L(mm)	A(mm)	pcs/case
1500936	H92100	1.5	90	14	72 x 12
1500937	H92101	2	100	16	72 x 12
1500938	H92102	2.5	112	18	72 x 6
1500939	H92103	3	126	20	36 x 12
1500940	H92104	4	140	25	36 x 12
1500941	H92105	5	160	28	36 x 4
1500942	H92106	6	180	32	36 x 4
1500943	H92108	8	200	36	18 x 4
1500944	H92109	10	224	40	18 x 4

T-Handle Hex Key

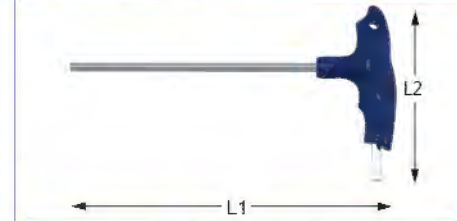

EBS No.	Item No.	SIZE(MM)	L1(mm)	L2(mm)	pcs/case
1502798	H94101	2	129	61.5	12 x 12
1502799	H94102	2.5	129	61	12 x 12
1502800	H94103	3	128.5	61	12 x 12
1502801	H94104	4	178	60.5	12 x 12
1502802	H94105	5	177.5	64	12 x 12
1502803	H94106	6	192	88	12 x 6
1502804	H94107	7	241.5	87.5	12 x 6
1502805	H94108	8	241	87	12 x 6
1502806	H94109	10	240	91	12 x 6

- S2 updated material, 30% better torque than cr-v material. End chamfer design, convenience for insert nut
- Ergonomic design handle, beautiful and comfortable

T-Handle Ball End Hex Key

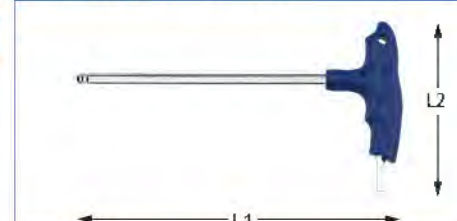

EBS No.	Item No.	SIZE(MM)	L1(mm)	L2(mm)	pcs/case
1502807	H94201	2	129	61.5	12 x 12
1502808	H94202	2.5	129	61	12 x 12
1502809	H94203	3	128.5	61	12 x 12
1502810	H94204	4	178	60.5	12 x 12
1502811	H94205	5	177.5	64	12 x 12
1502812	H94206	6	192	88	12 x 6
1502813	H94207	7	241.5	87.5	12 x 6
1502814	H94208	8	241	87	12 x 6
1502815	H94209	10	240	91	12 x 6

- S2 updated material, 30% better torque than cr-v material. End chamfer design, convenience for insert nut
- Ergonomic design handle, beautiful and comfortable

Long Hex Key-12MM Black



EBS No.	Item No.	SIZE(MM)	L(mm)	A(mm)	pcs/case
1502770	H91450	1.5	77	13.5	72x12 2.5
1502771	H91451	2	82	15.5	72x12 2.5
1502772	H91452	2.5	88.5	17.5	72 x 6 2.8
1502773	H91453	3	98.5	19	36x12 3
1502774	H91454	4	104	24	36x12 3.7
1502775	H91455	5	116	27	36 x 4 4.6
1502776	H91456	6	138	31	36 x 4 5.9
1502777	H91457	7	148	33	36 x 4 6.7
1502778	H91458	8	158	35	18 x 4 7.5
1502779	H91459	10	167	39	18 x 4 10
1502816	H95001	12	209	44	12 x 4 20
1502817	H95003	14	233	54.5	12 x 2 29.5
1502818	H95005	16	240	58.5	12 x 2 40
1502819	H95006	17	246	61.5	12 x 2 53
1502820	H95007	18	261	64.5	12 x 2 53
1502821	H95008	19	276	68.5	10 x 2 63.5
1502822	H95011	22	330	78	1 x 12 125
1502823	H95013	24	370	88	1 x 10 169
1502824	H95016	27	410	97.5	1 x 6 228
1502825	H95019	30	450	105	1 x 4 476
1502826	H95021	32	470	120	1 x 4 585
1502827	H95025	36	490	135	1 x 2 770

- Made of CR-V, quench finish, End chamfer design, convenience for insert nut
- Ergonomic design handle, beautiful and comfortable

H02412 1504032
9Pc T-Handle Ball End Hex Key Set (6pcs/case)



- Size: 2.2, 5.3, 4.5, 6.7, 8, 10
- New SVCM+ material, 30% better torque than CRV material
- Ergonomic handle design, make the user feel more flexible
- Full Polished Surface for oil permeate

H02413 1504033
9Pc T-Handle Hex Key Set (6pcs/case)



- Size: 2.2, 5.3, 4.5, 6.7, 8, 10
- New SVCM+ material, 30% better torque than CRV material
- Ergonomic handle design, make the user feel more flexible
- Full Polished Surface for oil permeate



Screwdriver & Bits

H02500 1500043

7PC. INSULATED SCREWDRIVER SET (6set/ctn)



DESCRIPTION:
PHILLIPS-PH 0X60mm,PH 1x80mm,PH 1x100mm
SLOTTED-2.5X75mm,,4x100mm,5.5x125mm,6.5 x150mm
ROD is made of chrome-vanadium-molybdenum
Soft-grip handle is made of TPR and PP material
Soft-grip handle comes in dual colour
Meets DIN standards,VDE and GS certification
Up to 1000V

H02520 1501589

7Pc VDE Insulated Screwdriver Set (6set/ctn)



Professional VDE Insulated Screwdriver-Slot,2.5X75MM
Professional VDE Insulated Screwdriver-Slot,4X100MM
Professional VDE Insulated Screwdriver-Slot,5X125MM
Professional VDE Insulated Screwdriver-Slot,5X150MM
Professional VDE Insulated Screwdriver-Phillips,0#X60MM
Professional VDE Insulated Screwdriver-Phillips,1#X80MM
Professional VDE Insulated Screwdriver-Phillips,2#X100MM

Remark :
• Ensure VDE didn't break before use
• Ensure VDE clean and dry
• Screwdriver is precision tools, use suitable size
• Take safety clothes, gloves and insulated mat for Protection
• Careful transport and store to prevent the insulated layer

H02501 1500044

8PC. SCREWDRIVER SET (6set/ctn)



DESCRIPTION:
PHILLIPS-PH1X75mm,PH2x38mm,PH2x100 mm,PH2x150mm
SLOTTED-5X75mm,6x38mm,6x100mm,6x15 0mm

H02502 1500045

6PC. SCREWDRIVER SET (6set/ctn)



DESCRIPTION:
PHILLIPS-PH1X80mm,PH2x100mm,PH2x150mm
SLOTTED-5X80mm,6x100mm,6x150mm

H02503 1501578

8Pc Screwdriver Set -Star (6set/ctn)



(T-8x75MM,T-10x100MM,T-15x100MM, T-20x100MM,T-25x10MM,T-27x100MM, T-30x100MM,T-40x100MM)

INSULATED SLOTTED SEREWDRIER

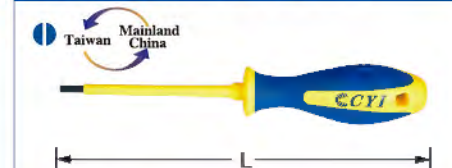

EBS No.	Item No.	SIZE(MM)	L(mm)	W(mm)	pcs case
1500696	H33100	2.5x75	165	2.5	12 x 8
1500697	H33101	3x100	190	3.0	12 x 8
1500698	H33102	4x100	179	4.0	12 x 8
1500699	H33103	5.5x125	229	5.5	12 x 8
1500700	H33104	6.5x150	265	6.5	10 x 8

INSULATED SLOTTED SEREWDRIER



EBS No.	Item No.	SIZE(MM)	L(mm)	W(mm)	pcs case
1500706	H33200	PH0x60	150	3.0	12 x 8
1500707	H33201	PH1x80	184	4.5	12 x 8
1500708	H33202	PH2x100	215	6.0	12 x 8
1500709	H33203	PH3x150	275	8.0	8 x 8

Rod is made of chrome-vanadium-molybdenum
Soft-grip handle is made of TPR and PP material
Soft-grip handle comes in dual colour
Meets DIN standards,VDE and GS certification
Up to 1000V

INSULATED PHILLIPS SEREWDRIER



EBS No.	Item No.	SIZE(MM)	L(mm)	W(mm)	pcs case
1500701	H33150	2.5x75	165	2.5	12 x 8
1500702	H33151	3x100	190	3.0	12 x 8
1500703	H33152	4x100	179	4.0	12 x 8
1500704	H33153	5.5x125	229	5.5	12 x 8
1500705	H33154	6.5x150	265	6.5	10 x 8

INSULATED PHILLIPS SEREWDRIER

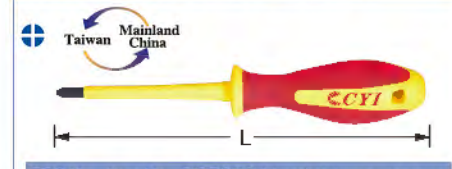

EBS No.	Item No.	SIZE(MM)	L(mm)	W(mm)	pcs case
1500710	H33250	PH0x60	150	3.0	12 x 8
1500711	H33251	PH1x80	184	4.5	12 x 8
1500712	H33252	PH2x100	215	6.0	12 x 8
1500713	H33253	PH3x150	275	8.0	8 x 8

Rod is made of chrome-vanadium-molybdenum
Soft-grip handle is made of TPR and PP material
Soft-grip handle comes in dual colour
Meets DIN standards,VDE and GS certification
Up to 1000V



PHILLIPS SCREWDRIVER

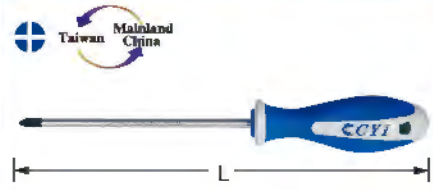

EBS No.	Item No.	SIZE(MM)	L(mm)	W(mm)	H(mm)	pcs case
1500674	H32250	PH0x80	150	3.0	12 x 8	
1500681	H32257	PH0x80	170	3.0	12 x 8	
1500682	H32258	PH0x100	190	3.0	12 x 8	
1500683	H32259	PH0x150	240	3.0	12 x 8	
1500684	H32260	PH1x80	184	5.0	12 x 8	
1500675	H32251	PH1x100	204	5.0	10 x 8	
1500685	H32262	PH1x150	254	5.0	10 x 8	
1500686	H32263	PH1x200	304	5.0	12 x 8	
1500676	H32252	PH2x100	215	6.0	12 x 8	
1500677	H32253	PH2x150	365	6.0	12 x 8	
1500678	H32254	PH2x200	315	6.0	12 x 8	
1500687	H32260	PH2x250	365	6.0	12 x 9	
1500688	H32267	PH2x300	415	6.0	12 x 9	
1500679	H32255	PH3x150	275	8.0	8 x 8	
1500686	H32256	PH3x200	325	8.0	8 x 8	
1500689	H32268	PH3x250	375	8.0	8 x 8	
1500690	H32269	PH3x300	425	8.0	8 x 8	

- ROD is made of chrome-vanadium steel, fully hardened and temper to provide maximum strength and durability SWCM
- Screwdriver tips are magnetized to find/find screws
- Handles are ergonomically designed to provide comfortable grip and safety

SLOTTED SCREWDRIVER

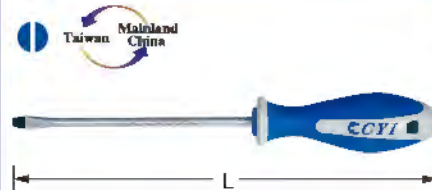

EBS No.	Item No.	SIZE(MM)	L(mm)	W(mm)	H(mm)	pcs case
1500655	H32157	3x60	150	3	12 x 8	
1500649	H32150	3x80	170	3	12 x 8	
1500655	H32158	3x100	190	3	12 x 8	
1500657	H32159	3x150	240	3	12 x 8	
1500658	H32165	5x80	184	5	12 x 8	
1500659	H32166	5x100	204	5	12 x 9	
1500660	H32167	5x150	254	5	12 x 8	
1500650	H32152	6x100	215	6	12 x 8	
1500651	H32153	6x150	265	6	12 x 8	
1500652	H32154	6x200	315	6	12 x 8	
1500653	H32155	8x150	275	8	10 x 8	
1500654	H32156	8x200	325	8	10 x 8	

- ROD is made of chrome-vanadium steel, fully hardened and temper to provide maximum strength and durability SWCM+
- Screwdriver tips are magnetized to find/find screws
- Handles are ergonomically designed to provide comfortable grip and safety

PHILLIPS SCREWDRIVER

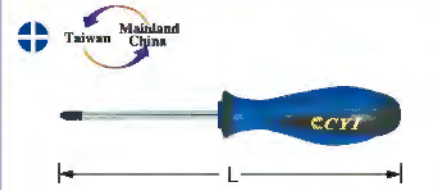

EBS No.	Item No.	SIZE(MM)	L(mm)	W(mm)	H(mm)	pcs case
1500661	H32200	PH0x80	170	3	12 x 8	
1500662	H32201	PH0x100	190	3	12 x 8	
1500663	H32202	PH0x150	240	3	12 x 8	
1500664	H32204	PH1x80	184	5	12 x 8	
1500665	H32205	PH1x100	204	5	12 x 8	
1500666	H32205	PH1x150	254	5	12 x 9	
1500667	H32207	PH1x200	304	5	12 x 9	
1500668	H32209	PH2x100	215	6	12 x 8	
1500669	H32210	PH2x150	265	6	12 x 8	
1500670	H32211	PH2x200	315	6	12 x 8	
1500671	H32212	PH2x250	365	6	8 x 8	
1500672	H32213	PH3x150	275	8	10 x 8	
1500673	H32214	PH3x200	325	8	10 x 8	

- ROD is made of chrome-vanadium steel, fully hardened and temper to provide maximum strength and durability SWCM
- Screwdriver tips are magnetized to find/find screws
- Handles are ergonomically designed to provide comfortable grip and safety

SLOTTED SCREWDRIVER

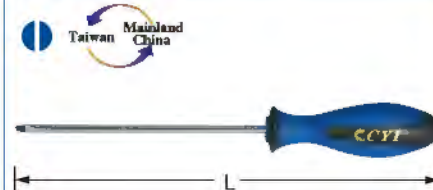

EBS No.	Item No.	SIZE(MM)	L(mm)	W(mm)	H(mm)	pcs case
1500637	H32100	3x80	170	3	12 x 8	
1500638	H32101	3x100	190	3	12 x 8	
1500639	H32102	3x150	240	3	12 x 8	
1500640	H32104	5x80	184	5	12 x 8	
1500641	H32105	5x100	204	5	12 x 8	
1500642	H32106	5x150	254	5	12 x 9	
1500643	H32107	5x200	304	5	12 x 8	
1500644	H32109	6x100	215	6	12 x 8	
1500645	H32110	6x150	265	6	12 x 8	
1500640	H32111	6x200	315	6	12 x 8	
1500647	H32113	8x150	275	8	10 x 8	
1500648	H32114	8x200	325	8	10 x 8	

- ROD is made of chrome-vanadium steel, fully hardened and temper to provide maximum strength and durability SVCM
- Screwdriver tips are magnetized to find/find screws
- Handles are ergonomically designed to provide comfortable grip and safety

SLOTTED SCREWDRIVER

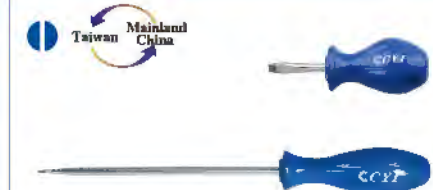

EBS No.	Item No.	SIZE(MM)	L(mm)	W(mm)	H(mm)	pcs case
1500581	H31100	3x75	165	3	12 x 8	
1500582	H31101	3x100	190	3	12 x 8	
1500583	H31102	3x150	240	3	12 x 6	
1500584	H31103	3x200	290	3	12 x 6	
1500585	H31104	5x75	169	5	12 x 8	
1500586	H31105	5x100	194	5	12 x 8	
1500587	H31106	5x150	244	5	12 x 8	
1500588	H31107	5x200	294	5	12 x 9	
1500596	H31115	5x250	344	5	12 x 8	
1500597	H31116	5x300	394	5	12 x 8	
1500589	H31108	6x38	142	6	12 x 8	
1500590	H31109	6x100	204	6	12 x 9	
1500591	H31110	6x150	254	6	10 x 8	
1500592	H31111	6x200	304	6	12 x 8	
1500593	H31112	6x250	354	6	8 x 9	
1500598	H31117	6x300	404	6	12 x 9	
1500594	H31113	8x150	365	8	10 x 8	
1500595	H31114	8x200	315	8	10 x 8	
1500599	H31118	8x250	365	8	8 x 8	
1500600	H31119	8x300	415	8	8 x 8	

- SVCM+ Cutter arbor , Integral quenching process, perfect HRC, durable for use long lifetime

PHILLIPS SCREWDRIVER

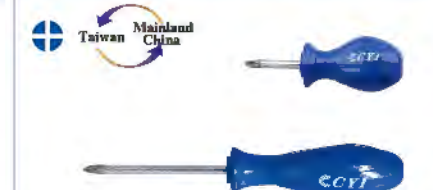

EBS No.	Item No.	SIZE(MM)	L(mm)	W(mm)	H(mm)	pcs case
1500601	H31200	PH0x75	165	3	12 x 8	
1500602	H31201	PH0x100	190	3	12 x 8	
1500603	H31202	PH0x150	240	3	12 x 6	
1500604	H31200	PH0x200	290	3	12 x 6	
1500605	H31204	PH1x75	169	5	12 x 8	
1500605	H31205	PH1x100	194	5	12 x 8	
1500607	H31206	PH1x150	244	5	12 x 8	
1500608	H31207	PH1x200	294	5	12 x 9	
1500616	H31215	PH1x250	344	5	12 x 8	
1500617	H31216	PH1x300	394	5	12 x 8	
1500609	H31208	PH2x38	142	6	12 x 8	
1500610	H31209	PH2x100	204	6	12 x 9	
1500611	H31210	PH2x150	254	6	10 x 8	
1500612	H31211	PH2x200	304	6	12 x 8	
1500613	H31212	PH2x250	354	6	8 x 9	
1500618	H31217	PH2x300	404	6	12 x 9	
1500611	H31213	PH3x150	265	8	10 x 8	
1500612	H31214	PH3x200	315	8	10 x 8	
1500619	H31218	PH3x250	365	8	8 x 8	
1500620	H31219	PH3x300	415	8	8 x 8	

- SVCM+ Cutter arbor , Integral quenching process, perfect HRC, durable for use long lifetime

Go-Through Screwdriver -Phillips

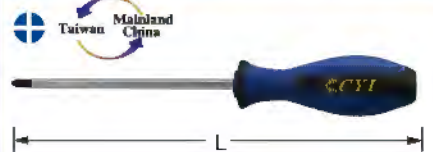

EBS No.	Item No.	SIZE(MM)	L(mm)	W(mm)	H(mm)	pcs case
1502099	H32701	PH2x100	218.0	6	12 x 8	
1501416	H32702	PH2x150	268.0	6	12 x 8	
1501417	H32703	PH3x150	278.5	8	12 x 8	
1501418	H32704	PH3x200	328.5	8	8 x 8	
1501419	H32705	PH3x250	378.5	8	8 x 8	

- ROD is made of chrome-vanadium steel, fully hardened and temper to provide maximum strength and durability
- Screwdriver tips are magnetized to find/find screws
- ANSI B107.15 DIN 5246 Standard

Go-Through Screwdriver -Slot

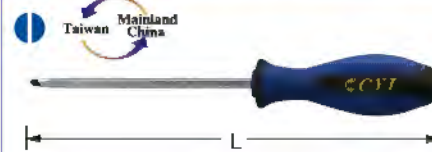

EBS No.	Item No.	SIZE(MM)	L(mm)	W(mm)	H(mm)	pcs case
1501409	H32601	6x100	218.0	6	12 x 8	
1501410	H32602	6x150	268.0	6	12 x 8	
1501411	H32603	8x150	278.5	8	12 x 8	
1501412	H32604	8x200	328.5	8	8 x 8	
1501413	H32605	8x250	378.5	8	8 x 8	

- ROD is made of chrome-vanadium steel, fully hardened and temper to provide maximum strength and durability
- Screwdriver tips are magnetized to find/find screws
- ANSI B107.15 DIN 5246 Standard

DUAL HEAD SCREWDRIVER

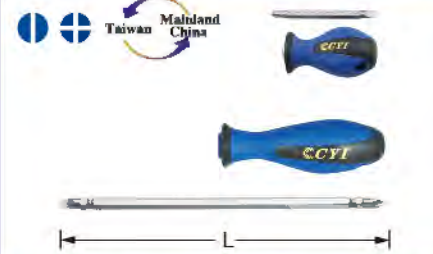

EBS No.	Item No.	SIZE(MM)	W(mm)	pcs case
1500691	H32500	PH2&6x38	6	12
1500692	H32501	PH1&5x100	5	12
1500693	H32502	PH2&6x100	6	12
1500694	H32503	PH1&5x150	5	12
1500695	H32504	PH2&6x150	6	12

- ROD is made of chrome-vanadium steel, fully hardened and temper to provide maximum strength and durability
- ANSI B107.15 DIN 5246 Standard



TORX SCREWDRIVER

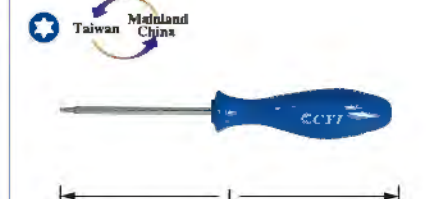

EBS No.	Item No.	SIZE(MM)	L(mm)	W(mm)	H(mm)	pcs case
1500627	H31307	T8x75	204	6	12 x 8	
1500621	H31300	T10x100	165	3	12 x 8	
1500622	H31301	T15x100	194	5	12 x 8	
1500623	H31302	T20x100	194	5	12 x 8	
1500624	H31303	T25x100	194	5	12 x 8	
1500625	H31304	T27x100	204	6	12 x 8	
1500626	H31305	T30x100	204	6	12 x 8	
1500627	H31305	T40x100	204	6	12 x 8	

- SVCM+ Cutter arbor , Integral quenching process, perfect HRC, durable for use long lifetime

NUT DRIVER

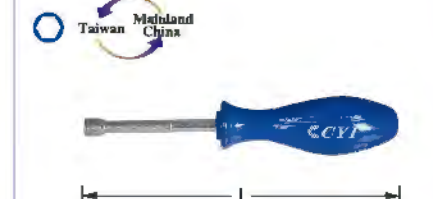

EBS No.	Item No.	SIZE(MM)	L(mm)	W(mm)	H(mm)	pcs case
1500629	H31400	5x75	179	6	12 x 8	
1500630	H31401	6x75	179	6	12 x 8	
1500631	H31402	7x75	179	6	12 x 8	
1500632	H31400	8x75	179	6	12 x 8	
1500633	H31404	9x75	179	6	12 x 8	
1500634	H31405	10x75	179	6	12 x 8	
1500635	H31406	11x75	179	6	12 x 8	
1500636	H31407	12x75	179	6	12 x 8	

- SVCM+ Cutter arbor , Integral quenching process, perfect HRC, durable for use long lifetime

Impact Screwdriver-Phillips, Cushion Grip



EBS No.	Item No.	SIZE(MM)	pcs case
1502100	H32751	PH2x100	12 x 8
1502101	H32752	PH2x150	12 x 8
1502102	H32753	PH3x150	12 x 8
1502103	H32754	PH3x200	8 x 8
1502104	H32755	PH3x250	8 x 8

- PP Handle
- CRV Body

Screwdriver-Phillips, Cushion Grip



EBS No.	Item No.	SIZE(MM)	pcs case
1502038	H30100	3.2x75	12 x 8
1502039	H30101	3.2x100	12 x 8
1502040	H30102	3.2x150	12 x 8
1502041	H30103	3.2x200	12 x 8
1502042	H30104	5.5x75	12 x 8
1502043	H30105	5.5x100	12 x 8
1502044	H30106	5.5x150	12 x 8
1502045	H30107	5.5x200	12 x 9
1502046	H30108	6.5x38	12 x 8
1502047	H30109	6.5x100	12 x 8
1502048	H30110	6.5x150	12 x 8
1502049	H30111	6.5x200	12 x 9
1502050	H30112	6.5x250	10 x 8
1502051	H30113	8.0x150	12 x 8
1502052	H30114	8.0x200	8 x 9
1502053	H30115	5.5x250	12 x 9
1502054	H30116	5.5x300	10 x 8
1502055	H30117	6.5x300	10 x 8
1502056	H30118	8.0x250	8 x 8
1502057	H30119	8.0x300	8 x 8

- PP Handle
- CRV Body

Impact Screwdriver-Slot, Cushion Grip



EBS No.	Item No.	SIZE(MM)	pcs case
1502094	H32651	6x100	12 x 8
1502095	H32652	6x150	12 x 8
1502096	H32653	8x150	12 x 8
1502097	H32654	8x200	8 x 8
1502098	H32655	8x250	8 x 8

- PP Handle
- CRV Body

Screwdriver-Slot, Cushion Grip



EBS No.	Item No.	SIZE(MM)	pcs case
1502058	H30200	PH0x75	12 x 8
1502059	H30201	PH0x100	12 x 8
1502060	H30202	PH0x150	12 x 8
1502061	H30203	PH0x200	12 x 8
1502062	H30204	PH1x75	12 x 8
1502063	H30205	PH1x100	12 x 8
1502064	H30206	PH1x150	12 x 8
1502065	H30207	PH1x200	12 x 9
1502066	H30208	PH2x38	12 x 8
1502067	H30209	PH2x100	12 x 8
1502068	H30210	PH2x150	12 x 8
1502069	H30211	PH2x200	12 x 9
1502070	H30212	PH2x250	10 x 8
1502071	H30213	PH3x150	12 x 8
1502072	H30214	PH3x200	8 x 9
1502073	H30215	PH1x250	12 x 9
1502074	H30216	PH1x300	10 x 8
1502075	H30217	PH2x300	10 x 8
1502076	H30218	PH3x250	8 x 8
1502077	H30219	PH3x300	8 x 8

- PP Handle
- CRV Body

Impact Screwdriver-Star, Cushion Grip



EBS No.	Item No.	SIZE(MM)	pcs case
1502078	H30300	T8x75	12 x 8
1502079	H30301	T10x100	12 x 8
1502080	H30302	T15x100	12 x 8
1502081	H30303	T20x100	12 x 8
1502082	H30304	T25x100	12 x 8
1502083	H30305	T27x100	12 x 8
1502084	H30306	T30x100	12 x 8
1502085	H30307	T40x100	12 x 8

- PP Handle
- CRV Body

Screwdriver-Dual Head, Cushion Grip



EBS No.	Item No.	SIZE(MM)	pcs case
1504000	H30500	PH2&6X38	6 x 6
1504001	H30501	PH1&5X100	6 x 6
1504002	H30502	PH2&6X100	6 x 6
1504003	H30503	PH1&5X150	6 x 6
1504004	H30504	PH2&6X150	6 x 6

- PP Handle
- CRV Body

Screwdriver-Nut, Cushion Grip



EBS No.	Item No.	SIZE(MM)	pcs case
1502086	H30400	5.0x75	12 x 8
1502087	H30401	6.0x75	12 x 8
1502088	H30402	7.0x75	12 x 8
1502089	H30403	8.0x75	12 x 8
1502090	H30404	9.0x75	12 x 8
1502091	H30405	10.0x75	12 x 8
1502092	H30406	11.0x75	12 x 8
1502093	H30407	12.0x75	12 x 8

- PP Handle
- CRV Body

H02521 1503075
8Pc Impact Screwdriver set (6setx8case)



- Bit Adaptor
- 8MM Dr. Bit-Slot. 8MM, 70MM L
 - 8MM Dr. Bit-Slot. 8MM, 30MM L
 - 8MM Dr. Bit-Slot. 10MM, 30MM L
 - 8MM Dr. Bit-Phillips. PH2, 70MM L
 - 8MM Dr. Bit-Phillips. PH2, 30MM L
 - 8MM Dr. Bit-Phillips. PH3, 30MM L

H02522 1503073
8Pc Impact Screwdriver set (6setx8case)



- Bit Adaptor
- 8MM Dr. Bit-Slot. 8MM, 70MM L
 - 8MM Dr. Bit-Slot. 8MM, 30MM L
 - 8MM Dr. Bit-Slot. 10MM, 30MM L
 - 8MM Dr. Bit-Phillips. PH2, 70MM L
 - 8MM Dr. Bit-Phillips. PH2, 30MM L
 - 8MM Dr. Bit-Phillips. PH3, 30MM L

H02603 1501594
42Pc 8MM Dr Bit Set (6setx8case)



- 7Pc 8MM Dr Bit Set-Security Star,30MM L (T20 , T25 , T30 , T40 , T45 , T50 , T55)
- 5Pc 8MM Dr. Bit Set-30MM L 12pt (M-5 , M-6 , M-8 , M-10 , M-12)
- 7Pc 8MM Dr Bit Set-Hex,30MM L (4,5,6,7,8,10,12MM)
- 9Pc 8MM Dr Bit Set-Star,70MM L (T20 , T25 , T27 , T30 , T40 , T45 , T50 , T53 , T55)
- 7Pc 8MM Dr Bit Set-Hex,70MM L (4,5,6,7,8,10,12MM)
- 5Pc 8MM Dr. Bit Set-70MM L 12pt (M-5 , M-6 , M-8 , M-10 , M-12)
- 1Pc 12.5MM Bit Holder 5/16"
- 1Pc 10MM Bit Holder 5/16"

H02601 1501592
60Pc 6.3MM Dr Socket & Bit Set (6setx8case)



- 14Pc 6.3MM Dr. Socket Set (3,5,4,4.5,5,5.5,6,7,8,9,10,11,12,13,14MM)
- 7Pc 6.3MM Dr. Bit Set-Star. 25 MM L (T10 , T15 , T20 , T25 , T27 , T30 , T40)
- 7Pc 6.3MM Dr. Bit Set-Security Star. 25 MM L (T10,T15,T20,T25,T27,T30,T40)
- 4Pc 6.3MM Dr. Bit Set-Phillips. 25 MM L (PH0 , PH1 , PH2 , PH3)
- 4Pc 6.3MM Dr. Bit Set-Slot. 25 MM L (3,4,5,5.5,6.5MM)
- 6Pc 6.3MM Dr. Bit Set-Hex. 25 MM L (2,2.5,3,4,5,6MM)
- 3Pc 6.3MM Dr. Bit Set-Slot. 50 MM L (4,5,5.6,5MM)
- 3Pc 6.3MM Dr. Bit Set-Star. 50 MM L (T15 , T20 , T25)
- 3Pc 6.3MM Dr. Bit Set-Phillips. 50 MM L (PH1,PH2,PH3)
- 3Pc 6.3MM Dr. Bit Set-Hex. 50 MM L (4,5,6MM)
- 1Pc 6.3MM Dr. Bit Holder. 25MM L
- 1Pc 6.3MM Dr. Bit Holder. 50MM L
- 1Pc 6.3MM Dr. Magnetic Bit Holder
- 1Pc Ratcheting Multi Bit Driver
- 1Pc 6.3MM Bit Holder
- 1Pc 6.3MM Flexible Adaptor-6"

H02602 1501593
80Pcs 6.3MM Dr Bit Set



- 6Pc 6.3MM Dr. Bit Set-Slot. 25 MM L (3,4,5,5.5,6,6.5MM)
- 5Pc 6.3MM Dr. Bit Set-Phillips. 25 MM L (PH0,PH1,PH2,PH3)
- 8Pc 6.3MM Dr. Bit Set-Star. 25 MM L (T8,T10,T15,T20,T25,T27,T30,T40)
- 8Pc 6.3MM Dr. Bit Set-Security Star. 25 MM L (T8,T10,T15,T20,T25,T27,T30,T40)
- 6Pc 6.3MM Dr. Bit Set-Hex. 25 MM L (2,2.5,3,4,5,6MM)
- 6Pc 6.3MM Dr. Bit Set-Slot. 50 MM L (3,4,5,5.5,6,6.5MM)
- 6Pc 6.3MM Dr. Bit Set-Phillips. 50 MM L (PH0,PH1,PH2,PH3)
- 8Pc 6.3MM Dr. Bit Set-Security Star. 50 MM L (T8,T10,T15,T20,T25,T27,T30,T40)
- 6Pc 6.3MM Dr. Bit Set-Hex. 50 MM L (2,2.5,3,4,5,6MM)
- 8Pc 6.3MM Dr. Bit Set-Star. 50 MM L (T8,T10,T15,T20,T25,T27,T30,T40)
- 11Pc 6.5MM Dr. Bit Set-Phillips. 65MM L (PH1-PH1,PH2-PH2,PH3-PH3,4.5MM-PH1,5.5MM-PH2,6.5MM-PH3,PH1-PH2,PH2-PH3,PH1-PH1,PH2-PH2,PH3-PH3)
- 1Pc 6.3MM Dr. Bit Holder. 25MM L
- 1Pc 6.3MM Dr. Bit Holder. 50MM L
- 1Pc 6.3MM Dr. Magnetic Bit Holder
- 1Pc Ratcheting Multi Bit Driver

H02611 1501595
32Pc 6.3MM Dr Hand Drive Bit Set (6setx8case)



- 6pcs 6.3MM Dr Bit Hex,25MM L , (3,4,5,6,7,8)
- 7pcs 6.3MM Dr Bit Star,25MM L , (T8,T10,T15,T20,T25,T30,T40)
- 4pcs 6.3MM Dr Bit Slot,25MM L , (4.5,5,6,6.5)
- 4pcs 6.3MM Dr Bit Phillips,25MM L,(PH0,PH1,PH2,PH3)
- 6pcs 6.3MM Dr Bit Security Star,25MM L , (TT10,TT15,TT20,TT25,TT30,TT40)
- 3pcs 6.3MM Dr Bit Pozidriv,25MM L,(PZ1,PZ2,PZ3)

H02612 1501596
32Pc 6.3MM Dr Power Drive Bit Set



- 6pcs 6.3MM Dr Bit Hex,25MM L , (3,4,5,6,7,8)
- 7pcs 6.3MM Dr Bit Star,25MM L , (T8,T10,T15,T20,T25,T30,T40)
- 4pcs 6.3MM Dr Bit Slot,25MM L , (4.5,5,6,6.5)
- 4pcs 6.3MM Dr Bit Phillips,25MM L,(PH0,PH1,PH2,PH3)
- 6pcs 6.3MM Dr Bit Security Star,25MM L , (TT10,TT15,TT20,TT25,TT30,TT40)
- 3pcs 6.3MM Dr Bit Pozidriv,25MM L,(PZ1,PZ2,PZ3)
- 1pcs 6.3MM Dr Quick Release Bit Driver

H02613 1501346
32Pc 6.3MM Dr Pneumatic Drive Bit Set (6setx8case)



- 6pcs 6.3MM Dr Bit Hex,25MM L , (3,4,5,6,7,8)
- 7pcs 6.3MM Dr Bit Star,25MM L , (T8,T10,T15,T20,T25,T30,T40)
- 4pcs 6.3MM Dr Bit Slot,25MM L , (4.5,5,6,6.5)
- 4pcs 6.3MM Dr Bit Phillips,25MM L,(PH0,PH1,PH2,PH3)
- 6pcs 6.3MM Dr Bit Security Star,25MM L , (TT10,TT15,TT20,TT25,TT30,TT40)
- 3pcs 6.3MM Dr Bit Pozidriv,25MM L,(PZ1,PZ2,PZ3)
- 1pcs 6.3MM Dr Magnatic Bit Holder Extension



Magnetizing And Demagnetizing Device



EBS No.	Item No.	pcs-case
1502350	H38001	(100pcs/ctn)

- Used for Magnetizing or Demagnetizing the screw head or similar tools
- High quality plastic shell without cadmium(Cd), durable for impact

6.3MM Dr Magnatic Bit Holder Extension



EBS No.	Item No.	pcs-case
1501237	H35191	(13x6)

- Extension bar made of Stainless, full polish, high Precision
- Magnatic inside the extension bar
- Quick release bit function, convenient for using
- Bit made of CR-V, black finish

5Pc 1/4" DR. BIT POZI-DRIV



EBS No.	Item No.	SIZE(MM)	L(mm)	pcs case
1502238	H35550	PZ1	25	12 x 12
1502239	H35551	PZ2	25	12 x 12
1502240	H35552	PZ3	25	12 x 12

- S2 Upgrade alloy steel, SATIN finish, HRC60±2
- Sales Unit: 5pc/box

5Pc 1/4" DR. 50L PHILLIPS BIT



EBS No.	Item No.	SIZE(MM)	L(mm)	pcs case
1500774	H35620	PH0	50	12 x 12
1500775	H35621	PH1	50	12 x 12
1500776	H35622	PH2	50	12 x 12
1500777	H35623	PH3	50	12 x 12

- S2 Upgrade alloy steel, SATIN finish, HRC60±2
- Sales Unit: 5pc/box

5Pc 1/4" DR. 50L HEX BIT SOCKET (METRIC)



EBS No.	Item No.	SIZE(MM)	L(mm)	pcs case
1500786	H35660	2	50	12 x 12
1500787	H35661	2.5	50	12 x 12
1500788	H35662	3	50	12 x 12
1500789	H35663	4	50	12 x 12
1500790	H35664	5	50	12 x 12
1500791	H35665	6	50	12 x 12

- S2 Upgrade alloy steel, SATIN finish, HRC60±2
- Sales Unit: 5pc/box

5Pc 5/16" DR. SLOTTED BIT



EBS No.	Item No.	SIZE(MM)	L(mm)	pcs case
1500806	H35810	5.5	30	12 x 12
1500807	H35811	6.5	30	12 x 12
1500808	H35812	8	30	12 x 12
1500809	H35813	10	30	12 x 12
1500810	H35814	12	30	12 x 12

- S2 Upgrade alloy steel, SATIN finish, HRC60±2
- Sales Unit: 5pc/box

5Pc 1/4" DR. SLOTTED BIT



EBS No.	Item No.	SIZE(MM)	L(mm)	pcs case
1500744	H35510	3	25	12 x 12
1500745	H35511	4	25	12 x 12
1500746	H35512	5	25	12 x 12
1500747	H35513	5.5	25	12 x 12
1500748	H35514	6	25	12 x 12
1500749	H35515	6.5	25	12 x 12

- S2 Upgrade alloy steel, SATIN finish, HRC60±2
- Sales Unit: 5pc/box

5Pc 1/4" DR. TORX BIT



EBS No.	Item No.	SIZE(MM)	L(mm)	pcs case
1500754	H35530	T8	25	12 x 12
1500755	H35531	T10	25	12 x 12
1500756	H35532	T15	25	12 x 12
1500757	H35533	T20	25	12 x 12
1500758	H35534	T25	25	12 x 12
1500759	H35535	T27	25	12 x 12
1500760	H35536	T30	25	12 x 12
1500761	H35537	T40	25	12 x 12

- S2 Upgrade alloy steel, SATIN finish, HRC60±2
- Sales Unit: 5pc/box

5Pc 1/4" DR. HEX BIT SOCKET (METRIC)



EBS No.	Item No.	SIZE(MM)	L(mm)	pcs case
1500762	H35560	2	25	12 x 12
1500763	H35561	2.5	25	12 x 12
1500764	H35562	3	25	12 x 12
1500765	H35563	4	25	12 x 12
1500766	H35564	5	25	12 x 12
1500767	H35565	6	25	12 x 12
1502241	H35566	7	25	12 x 12
1502242	H35567	8	25	12 x 12

- S2 Upgrade alloy steel, SATIN finish, HRC60±2
- Sales Unit: 5pc/box

5Pc 1/4" DR. 50L TORX BIT



EBS No.	Item No.	SIZE(MM)	L(mm)	pcs case
1500778	H35630	T8	50	12 x 12
1500779	H35631	T10	50	12 x 12
1500780	H35632	T15	50	12 x 12
1500781	H35633	T20	50	12 x 12
1500782	H35634	T25	50	12 x 12
1500783	H35635	T27	50	12 x 12
1500784	H35636	T30	50	12 x 12
1500785	H35637	T40	50	12 x 12

- S2 Upgrade alloy steel, SATIN finish, HRC60±2
- Sales Unit: 5pc/box

5Pc 1/4" DR. DUAL HEAD SLOTTED BIT



EBS No.	Item No.	SIZE(MM)	L(mm)	pcs case
1500795	H35710	PH1-PH1	65	12 x 6
1500796	H35711	PH2-PH2	65	12 x 6
1500797	H35712	PH3-PH3	65	12 x 6
1500798	H35713	PH1-PH2	65	12 x 6
1500799	H35714	PH2-PH3	65	12 x 6
1500800	H35720	4.5MM-PH1	65	12 x 6
1500801	H35721	5.5MM-PH2	65	12 x 6
1500802	H35722	6.5MM-PH3	65	12 x 6
1500803	H35730	PH1-PH1	110	12 x 6
1500804	H35731	PH2-PH2	110	12 x 6
1500805	H35732	PH3-PH3	110	12 x 6

- S2 Upgrade alloy steel, SATIN finish, HRC60±2
- Sales Unit: 5pc/box

5Pc 5/16" DR. PHILLIPS BIT

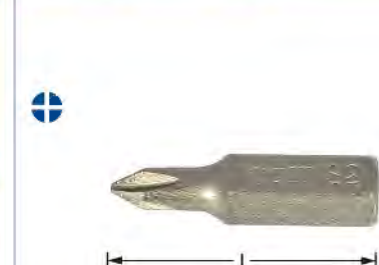

EBS No.	Item No.	SIZE(MM)	L(mm)	pcs case
1500811	H35820	PH1	30	12 x 12
1500812	H35821	PH2	30	12 x 12
1500813	H35822	PH3	30	12 x 12
1500814	H35823	PH4	30	12 x 12

- S2 Upgrade alloy steel, SATIN finish, HRC60±2
- Sales Unit: 5pc/box

5Pc 1/4" DR. PHILLIPS BIT



EBS No.	Item No.	SIZE(MM)	L(mm)	pcs case
1500750	H35520	PH0	25	12 x 12
1500751	H35521	PH1	25	12 x 12
1500752	H35522	PH2	25	12 x 12
1500753	H35523	PH3	25	12 x 12

- S2 Upgrade alloy steel, SATIN finish, HRC60±2
- Sales Unit: 5pc/box

5Pc 6.3MM Dr Bit Set-Security StarTT8,25MM L



EBS No.	Item No.	SIZE(MM)	L(mm)	pcs case
1502230	H35540	T8	25	12 x 12
1502231	H35541	T10	25	12 x 12
1502232	H35542	T15	25	12 x 12
1502233	H35543	T20	25	12 x 12
1502234	H35544	T25	25	12 x 12
1502235	H35545	T27	25	12 x 12
1502236	H35546	T30	25	12 x 12
1502237	H35547	T40	25	12 x 12

- S2 Upgrade alloy steel, SATIN finish, HRC60±2
- Sales Unit: 5pc/box

5Pc 1/4" DR. 50L SLOTTED BIT



EBS No.	Item No.	SIZE(MM)	L(mm)	pcs case
1500768	H35610	3	50	12 x 12
1500769	H35611	4	50	12 x 12
1500770	H35612	5	50	12 x 12
1500771	H35613	5.5	50	12 x 12
1500772	H35614	6	50	12 x 12
1500773	H35615	6.5	50	12 x 12

- S2 Upgrade alloy steel, SATIN finish, HRC60±2
- Sales Unit: 5pc/box

5Pc 6.3MM Dr Bit Set-Security StarTT8,50MM L



EBS No.	Item No.	SIZE(MM)	L(mm)	pcs case
1502243	H35640	T8	50	12 x 12
1502244	H35641	T10	50	12 x 12
1502245	H35642	T15	50	12 x 12
1502246	H35643	T20	50	12 x 12
1502247	H35644	T25	50	12 x 12
1502248	H35645	T27	50	12 x 12
1502249	H35646	T30	50	12 x 12
1502250	H35647	T40	50	12 x 12

- S2 Upgrade alloy steel, SATIN finish, HRC60±2
- Sales Unit: 5pc/box

H35715 1503128

5Pc 1/4" DR. Dual Head Phillips Megantic Bits Set (12pcs/6case)



- Size: PH2-PH2
- S2 Upgrade alloy steel, Stain finish, HRC60±2
- Sales Unit: 5Pc/SKU

5Pc 6.3MM Dr Bit Set-Security StarTT8,30MM L



EBS No.	Item No.	SIZE(MM)	L(mm)	pcs case
1502251	H35840	T20	30	12 x 12
1502252	H35841	T25	30	12 x 12
1502253	H35842	T30	30	12 x 12
1502254	H35843	T40	30	12 x 12
1502255	H35844	T45	30	12 x 12
1501424	H35845	T50	30	12 x 12

- S2 Upgrade alloy steel, SATIN finish, HRC60±2
- Sales Unit: 5pc/box

5Pc 5/16" DR. Hex Bit Set (METRIC)



EBS No.	Item No.	SIZE(MM)	L(mm)	pcs case
1500815	H35860	4	30	12 x 12
1500816	H35861	5	30	12 x 12
1500817	H35862	6	30	12 x 12
1500818	H35863	7	30	12 x 12
1500819	H35864	8	30	12 x 12
1500820	H35865	10	30	12 x 12
1500821	H35866	12	30	12 x 12

- S2 Upgrade alloy steel, SATIN finish, HRC60±2
- Sales Unit: 5pc/box

5Pc 8MM Dr Bit Set-Double Hex M5,30MM La



EBS No.	Item No.	SIZE(MM)	L(mm)	pcs case
1502256	H35870	M5	30	12 x 12
1502257	H35871	M6	30	12 x 12
1502258	H35872	M8	30	12 x 12
1502259	H35873	M10	30	12 x 12
1501425	H35874	M12	30	12 x 12

- S2 Upgrade alloy steel, SATIN finish, HRC60±2
- Sales Unit: 5pc/box

5Pc 8MM Dr Bit Set-Slot 8MM,70MM L



EBS No.	Item No.	SIZE(MM)	L(mm)	pcs case
1502260	H35910	8	70	12 x 6

- S2 Upgrade alloy steel, SATIN finish, HRC60±2
- Sales Unit: 5pc/box

5Pc 8MM Dr Bit Set-Phillips 2#,70MM L



EBS No.	Item No.	SIZE(MM)	L(mm)	pcs case
1502261	H35920	PH2	70	12 x 6

- S2 Upgrade alloy steel, SATIN finish, HRC60±2
- Sales Unit: 5pc/box

5Pc 8MM Dr Bit Set-Star T20,70MM La

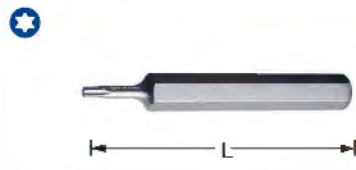

EBS No.	Item No.	SIZE(MM)	L(mm)	pcs case
1502262	H35930	T20	70	12 x 6
1502263	H35931	T25	70	12 x 6
1502264	H35932	T27	70	12 x 6
1502265	H35933	T30	70	12 x 6
1501426	H35934	T40	70	12 x 6
1502266	H35935	T45	70	12 x 6
1501427	H35936	T50	70	12 x 6
1502267	H35937	T55	70	12 x 6

- S2 Upgrade alloy steel, SATIN finish, HRC60±2
- Sales Unit: 5pc/box

5Pc 8MM Dr Bit Set-Hex 4MM,70MM L

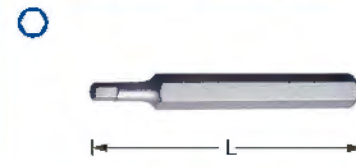

EBS No.	Item No.	SIZE(MM)	L(mm)	pcs case
1501428	H35960	4	70	12 x 6
1501429	H35961	5	70	12 x 6
1502268	H35962	6	70	12 x 6
1502269	H35963	7	70	12 x 6
1502270	H35964	8	70	12 x 6
1502271	H35965	10	70	12 x 6
1502272	H35966	12	70	12 x 6
1502273	H35967	14	70	12 x 6

- S2 Upgrade alloy steel, SATIN finish, HRC60±2
- Sales Unit: 5pc/box

5Pc 8MM Dr Bit Set-Double Hex M5,70MM L



EBS No.	Item No.	SIZE(MM)	L(mm)	pcs case
1502274	H35970	M5	70	12 x 6
1502275	H35971	M6	70	12 x 6
1502276	H35972	M8	70	12 x 6
1502277	H35973	M10	70	12 x 6
1501430	H35974	M12	70	12 x 6

- S2 Upgrade alloy steel, SATIN finish, HRC60±2
- Sales Unit: 5pc/box

5Pc 1/4"DR. Bit Holder Set



EBS No.	Item No.	SIZE(MM)	pcs case
1500792	H35690	25	12 x 12
1500793	H35691	50	12 x 12

- S2 Upgrade alloy steel, SATIN finish, HRC60±2
- Sales Unit: 5pc/box

5Pc 1/4"DR. Magnetic Bit Holder Set

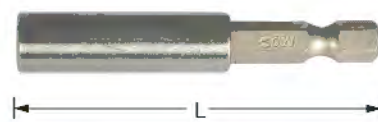

EBS No.	Item No.	SIZE(MM)	pcs case
1500794	H35692	60	12 x 12

3pcs. in plastic box

1/4"DR. MAGNETIC BIT SCREWDRIVER



EBS No.	Item No.	SIZE(MM)	pcs case
1500822	H36000	1/4"x100mm	12 x 8

- Professional for 6.3MM bit holder
- Magnetic cutter stick, ensure the bit didn't fall off

H37000 1502349

1/4" DR. BIT SCREW DRIVER(1pcsx36case)



- Torque : CRV forged extension bar and adaptor
- Magnet inside the adaptor, keep the bit stable when it work
- Firm/forward/reverse three rotation function
- Ergonomic handle design, make the user feel more flexible



H02012 1501503
3Pc VDE Insulated Pliers Set (3set/ctn)



- 1pcs VDE Insulated Lineman's Pliers-8"
- 1pcs VDE Insulated Diagonal Pliers-6"
- 1pcs VDE Insulated Long Nose Pliers-6"

H02013 1501504
9Pc VDE Insulated Pliers Tools Set (3set/ctn)



- 1pcs Professional VDE Insulated Screwdriver-Slot,2.5X75MM
- 1pcs Professional VDE Insulated Screwdriver-Slot,4X100MM
- 1pcs Professional VDE Insulated Screwdriver-Slot,5X125MM
- 1pcs Professional VDE Insulated Screwdriver-Phillips,0X60MM
- 1pcs Professional VDE Insulated Screwdriver-Phillips,1X80MM
- 1pcs Professional VDE Insulated Screwdriver-Phillips,2X100MM
- 1pcs VDE Insulated Lineman's Pliers-8"
- 1pcs VDE Insulated Diagonal Pliers-6"
- 1pcs VDE Insulated Long Nose Pliers-6"

VDE Insulated Stripping Pliers-6"



EBS No.	Item No.	SIZE	L(MM)	pcs-case
1502452	H51401	6"	160	6 x 8

• ANSI And ASME B107.13M Standard

VDE Insulated Pump Pliers-9.5"



EBS No.	Item No.	SIZE	L(MM)	pcs-case
1502453	H51511	9.5"	250	2 x 8

• ANSI And ASME B107.13M Standard

VDE INSULATED LINESMAN PLIERS



EBS No.	Item No.	SIZE	L(MM)	pcs-case
1500846	H51101	6"	170	4 x 8
1502450	H51102	7"	180	3 x 8
1500847	H51103	8"	210	3 x 8

• ANSI And ASME B107.13M Standard

VDE INSULATED LONG NOSE PLIERS



EBS No.	Item No.	SIZE	L(MM)	pcs-case
1500850	H51201	6"	170	4 x 8
1500851	H51202	8"	210	4 x 8

• ANSI And ASME B107.13M Standard

VDE INSULATED DIAGONAL PLIERS



EBS No.	Item No.	SIZE	L(MM)	pcs-case
1500854	H51301	6"	168	3 x 8
1502451	H51302	7"	180	3 x 8

• ANSI And ASME B107.13M Standard

LINESMAN PLIERS

Is about to go



订货号	产品编号	规格	最大剪切能力(mm)	个x盒	牌价
1500856	H53100	6"	铜丝026, 铁丝024, 硬铝丝020	4x8	48.9
1500857	H53101	7"	铜丝026, 铁丝024, 硬铝丝020	4x8	52.9
1500858	H53102	8"	铜丝026, 铁丝025, 硬铝丝023	4x8	53.9

DIAGONAL PLIERS

Is about to go



订货号	产品编号	规格	最大剪切能力(mm)	个x盒	牌价
1500861	H53300	5"	铜丝022, 铁丝020, 硬铝丝016	4x8	41.9
1500862	H53301	6"	铜丝026, 铁丝024, 硬铝丝020	4x8	42.9
1500863	H53302	7"	铜丝026, 铁丝025, 硬铝丝023	4x8	52.9

LONG NOSE PLIERS

Is about to go



订货号	产品编号	规格	最大剪切能力(mm)	个x盒
1500859	H53200	6"	铜丝022, 铁丝020, 硬铝丝016	4x8
1500860	H53201	8"	铜丝026, 铁丝024, 硬铝丝020	4x8

Linesman Pliers-Dipping Handle

Is about to go



EBS No.	Item No.	SIZE	pcs-case
1502454	H53150	6"	5 x 10
1502455	H53151	7"	5 x 10
1502456	H53152	8"	5 x 10

Diagonal Pliers-Dipping Handle

Is about to go



EBS No.	Item No.	SIZE	pcs-case
1502460	H53351	6"	5 x 10
1502461	H53352	7.5"	5 x 10

Long Nose Pliers-Dipping Handle

Is about to go



EBS No.	Item No.	SIZE	pcs-case
1502457	H53250	6"	5 x 10
1502458	H53251	8"	5 x 10

Circlip Pliers Ext. Straight, Germany Type

Is about to go



EBS No.	Item No.	SIZE	pcs-case
1502479	H58101	5"	6 x 4
1502480	H58102	7"	12x 4
1502481	H58103	9"	6 x 4
1502482	H58104	13"	6 x 4

Circlip Pliers Ext. Bent, Germany Type

Is about to go



EBS No.	Item No.	SIZE	pcs-case
1502483	H58105	5"	6 x 4
1502484	H58106	7"	12x 3
1502485	H58107	9"	6 x 4
1502486	H58108	13"	6 x 4

Circlip Pliers Int. Bent, Germany Type

Is about to go



EBS No.	Item No.	SIZE	pcs-case
1502493	H58205	5"	6 x 4
1502494	H58206	7"	12x 4
1502495	H58207	9"	6 x 4
1502496	H58208	13"	6 x 4

Circlip Pliers Int. Straight, Germany Type

Is about to go



EBS No.	Item No.	SIZE	pcs-case
1502489	H58201	5"	6 x 4
1502490	H58202	7"	12x 4
1502491	H58203	9"	6 x 4
1502492	H58204	13"	6 x 4

Circlip Pliers Int. Straight

Is about to go

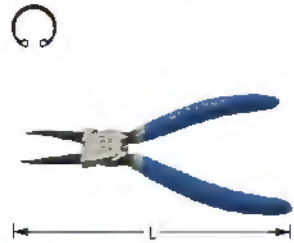

EBS No.	Item No.	SIZE	pcs-case
1502497	H58250	7"	12x 4

Circlip Pliers Int. Bent

Is about to go

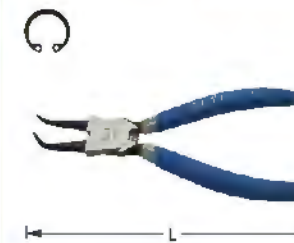

EBS No.	Item No.	SIZE	pcs-case
1502498	H58251	7"	12x 3

Circlip Pliers Ext. Straight

Is about to go

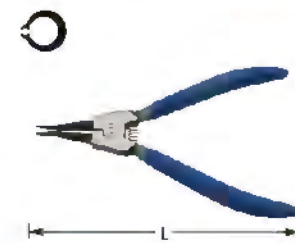

EBS No.	Item No.	SIZE	pcs-case
1502487	H58150	7"	12 x 4

Circlip Pliers Ext. Bent

Is about to go

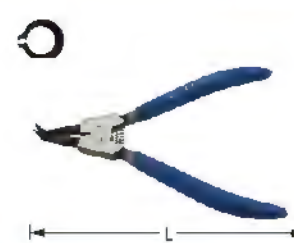

EBS No.	Item No.	SIZE	pcs-case
1502488	H58151	7"	12x 3

Professional Linesman's Pliers



EBS No.	Item No.	SIZE	pcs case
1503925	H53110	6"	4 x 8
1503926	H53111	7"	4 x 8
1503927	H53112	8"	4 x 8

Professional Diagonal Pliers



EBS No.	Item No.	SIZE	pcs case
1503930	H53310	5"	4 x 8
1503931	H53311	6"	4 x 8
1503932	H53312	7"	4 x 8

Professional Long Nose Pliers



EBS No.	Item No.	SIZE	pcs case
1503928	H53210	6"	4 x 8
1503929	H53211	8"	4 x 8

Linesman Pliers-Dipping Handle



订货号	产品编号	规格	最大剪切能力(mm)	个x盒	牌价
1503917	H53160	6"	钢丝02.6, 铁丝02.4, 硬钢丝02.0	5x10	34.9
1503918	H53161	7"	钢丝02.6, 铁丝02.4, 硬钢丝02.0	5x10	36.9
1503919	H53162	8"	钢丝02.6, 铁丝02.5, 硬钢丝02.3	5x10	37.5

Diagonal Pliers-Dipping Handle



订货号	产品编号	规格	最大剪切能力(mm)	个x盒	牌价
1503922	H53361	6"	钢丝02.6, 铁丝02.4, 硬钢丝02.0	5x10	26.5
1503923	H53362	7.5"	钢丝02.6, 铁丝02.5, 硬钢丝02.3	5x10	35.5

Long Nose Pliers-Dipping Handle



订货号	产品编号	规格	最大剪切能力(mm)	个x盒	牌价
1503920	H53260	6"	钢丝02.2, 铁丝02.0, 硬钢丝01.6	5x10	
1503921	H53261	8"	钢丝02.6, 铁丝02.4, 硬钢丝02.0	5x10	

Circlip Pliers Ext. Straight, Germany Type



EBS No.	Item No.	SIZE	pcs case
1506407	H58119	5"	6 x 4
1506408	H58120	7"	12x 4
1506409	H58121	9"	6 x 4
1506410	H58122	13"	6 x 4

- Pliers body made with durable CR-V
- DIN 5286 standard

Circlip Pliers Ext. Bent, Germany Type



EBS No.	Item No.	SIZE	pcs case
1506411	H58123	5"	6 x 4
1506412	H58124	7"	12x 3
1506413	H58125	9"	6 x 4
1506414	H58126	13"	6 x 4

- Pliers body made with durable CR-V
- DIN 5286 standard

Circlip Pliers Int. Bent, Germany Type



EBS No.	Item No.	SIZE	pcs case
1506419	H58223	5"	6 x 4
1506420	H58224	7"	12x 4
1506421	H58225	9"	6 x 4
1506422	H58226	13"	6 x 4

- Pliers body made with durable CR-V
- DIN 5286 standard

Circlip Pliers Int. Straight, Germany Type



EBS No.	Item No.	SIZE	pcs case
1506415	H58219	5"	6 x 4
1506416	H58220	7"	12x 4
1506417	H58221	9"	6 x 4
1506418	H58222	13"	6 x 4

- Pliers body made with durable CR-V
- DIN 5286 standard

Circlip Pliers Int. Straight



EBS No.	Item No.	SIZE	pcs case
1506425	H58252	7"	12 x 4

- CR-V forged body, high strength

Circlip Pliers Int. Bent



EBS No.	Item No.	SIZE	pcs case
1506426	H58253	7"	12 x 3

- CR-V forged body, high strength

Circlip Pliers Ext. Straight



EBS No.	Item No.	SIZE	pcs case
1506423	H58152	7"	12 x 4

Circlip Pliers Ext. Bent



EBS No.	Item No.	SIZE	pcs case
1506424	H58153	7"	12 x 3

Plier-Cusion Grip



Cut HRC 55-65 steel wire

Cusion Grip Handle

Full polish after Black finish, prevent rusting

- Economy series, performance cost, for basic repairing use
- Special designed patent appearance, Innervation, Streamline
- Special designed for Asia hand, decrease tiredness.

Mini Lineman's Pliers



EBS No.	Item No.	SIZE	pcs case
1502463	H54150	4.5"	10x10

Mini Diagonal Pliers



EBS No.	Item No.	SIZE	pcs case
1502465	H54350	4.5"	10x10

Mini Flat Nose Pliers



EBS No.	Item No.	SIZE	pcs case
1502467	H54550	4.5"	10x10

Mini Long Nose Pliers



EBS No.	Item No.	SIZE	pcs case
1502464	H54250	4.5"	10x10

Mini Bent Nose Pliers



EBS No.	Item No.	SIZE	pcs case
1502466	H54450	4.5"	10x10

Mini End Cutting Pliers



EBS No.	Item No.	SIZE	pcs case
1502468	H54650	4.5"	10x10

Linesman Pliers-High-Leverage



EBS No.	Item No.	SIZE	pcs-case
1501374	H53401	6"	4 x 8
1501375	H53402	7"	4 x 8
1501376	H53403	8"	4 x 8

- High Leverage Design, 45% Applying Force Saving
- Made Of Import Alloy Steel Gaining
- Imported Two Color Handle
- Inductive Heated Cutting Edge , Durability Gain 30% Life
- Comfortable And Anti -scratch

Diagonal Pliers-High-Leverage



EBS No.	Item No.	SIZE	pcs-case
1501378	H53601	6"	4 x 8
1501379	H53602	7"	4 x 8

- High Leverage Design, 45% Applying Force Saving
- Made Of Import Alloy Steel Gaining
- Imported Two Color Handle
- Inductive Heated Cutting Edge , Durability Gain 30% Life
- Comfortable And Anti -scratch

Long Nose Pliers-High-Leverage



EBS No.	Item No.	SIZE	pcs-case
1501390	H53501	6"	4 x 8
1501377	H53502	8"	4 x 8

- High Leverage Design, 45% Applying Force Saving
- Made Of Import Alloy Steel Gaining
- Imported Two Color Handle
- Inductive Heated Cutting Edge , Durability Gain 30% Life
- Comfortable And Anti -scratch

Mini LINESMAN PLIERS



EBS No.	Item No.	SIZE	pcs-case
1500864	H54100	4"	4 x 8

Mini BENT NOSE PLIERS



EBS No.	Item No.	SIZE	pcs-case
1500867	H54400	5"	4 x 8

Mini DIAGONAL PLIERS



EBS No.	Item No.	SIZE	pcs-case
1500866	H54300	4"	4 x 8

Mini LONG NOSE PLIERS



EBS No.	Item No.	SIZE	pcs-case
1500865	H54200	5"	4 x 8

Mini FLAT NOSE PLIERS



EBS No.	Item No.	SIZE	pcs-case
1500868	H54500	5"	4 x 8

Mini ATURE END NIPPERS PLIERS



EBS No.	Item No.	SIZE	pcs-case
1500869	H54600	4"	4 x 8

H02001

1501494

5Pc Circlip Pliers Set (6setx10case)



- 1pcs Plier
- 2pcs straight mouth head(1.3,1.3)
- 2pcs curve mouth head(45",90")

Slip Joint Pliers



EBS No.	Item No.	SIZE	L(MM)	ØMM	pcs-case
1502474	H56001	6"	159	5-30	6x10
1502475	H56002	8"	204	6-36	6x10

- A8 Style straight mouth design, made with CR-V
- ANSIB 107.23 and DIN 5231 standard

Heavy Duty Straight Pipe Wrench



EBS No.	Item No.	SIZE	pcs-case
1500899	H69000	8"	1x36
1500900	H69001	10"	1x24
1500901	H69002	12"	1x12
1500902	H69003	14"	1x12
1500903	H69004	18"	1x6
1500904	H69005	24"	1x4
1500905	H69006	36"	1x2
1500906	H69007	48"	1x2

- CR-V Plier Head
- Keep Powerful Clamping effect

G Clamp



EBS No.	Item No.	SIZE	pcs-case
1502509	H60001	3"	6 x 4
1502510	H60002	4"	4 x 4
1502511	H60003	6"	6 x 2
1502512	H60004	8"	1 x 8

Pump Pliers



EBS No.	Item No.	SIZE	ØMM	pcs-case
1502476	H57001	8"	4-31	6x10
1502477	H57002	10"	5-45	3x8
1502478	H57003	12"	5-54	3x8
1501326	H57004	16"	10-92	3x6
1501327	H57005	20"	10-120	2x6

- AB Style Straight Plier mouth, made with CR-V
- ANSIN 107.23M AND DIN 5231 Standard

Aluminum Pipe Wrench



EBS No.	Item No.	SIZE	pcs-case
1502673	H69011	10"	6 x 6
1502674	H69012	12"	6 x 4
1502675	H69013	14"	6 x 4
1502676	H69014	18"	2 x 6
1502677	H69015	24"	2 x 4
1502678	H69016	36"	1 x 2
1502679	H69017	48"	1 x 2

- Much lighter that normal plier pipe
- Kirsit handle, high torque, for almost kind of working condition use

Heavy Duty Bench Vice



EBS No.	Item No.	SIZE
1502665	H67001	4"
1502666	H67002	5"
1502667	H67003	6"
1502668	H67005	8"

- Made of high quality steel
- high strength clamping force ensure security
- Special designed Nut prevent broken and fall off
- Special designed bottom prevent slipping after lock

STRAIGHT JAW LOCKING PLIERS



EBS No.	Item No.	SIZE	L(MM)	pcs-case
1500873	H59200	7"	185	6x6
1500874	H59201	10"	224	3x9

- Si-Mn forged steel jaw , high strength
- CR-Mo alloy steel plier body, keep the original style
- Adjustable better clamp size

METAL SHEET CLAMP LOCKING PLIERS



EBS No.	Item No.	SIZE	L(MM)	pcs-case
1500878	H59401	8"	232	4x4

- Si-Mn forged steel jaw , high strength
- CR-Mo alloy steel plier body, keep the original style
- Adjustable better clamp size
- Circle head with cut function

US TYPE BENCH VICE



EBS No.	Item No.	SIZE
1502669	H67011	4"
1502670	H67012	5"
1502671	H67013	6"
1502672	H67015	8"

- Made of high quality steel
- high strength clamping force ensure security
- Special designed Nut prevent broken and fall off
- Special designed bottom prevent slipping after lock

LONG NOSE LOCKING PLIERS W/CUTTING EDGE



EBS No.	Item No.	SIZE	L(MM)	pcs-case
1500875	H59300	6"	169	6x6
1500876	H59301	9"	225	4x9

- Si-Mn forged steel jaw , high strength
- CR-Mo alloy steel plier body, keep the original style
- Adjustable better clamp size

C-CLAMP LOCKING PLIERS



EBS No.	Item No.	SIZE	L(MM)	pcs-case
1500879	H59402	11"	273	6x4

- Si-Mn forged steel jaw , high strength
- CR-Mo alloy steel plier body, keep the original style
- Adjustable better clamp size
- Circle head with cut function

CURVED JAW LOCKING PLIERS W/CUTTING EDGE



EBS No.	Item No.	SIZE	L(MM)	pcs-case
1500870	H59100	5"	144	6x8
1500871	H59101	7"	186	6x6
1500872	H59102	10"	244	3x9

- Si-Mn forged steel jaw , high strength
- CR-Mo alloy steel plier body, keep the original style
- Adjustable better clamp size
- Circle head with cut function

WELDING CLAMP LOCKING PLIERS



EBS No.	Item No.	SIZE	L(MM)	pcs-case
1500877	H59400	9"	204	4x4

- Si-Mn forged steel jaw , high strength
- CR-Mo alloy steel plier body, keep the original style
- Adjustable better clamp size

CHAIN CLAMP LOCKING PLIERS



EBS No.	Item No.	SIZE	L(MM)	pcs-case
1500880	H59403	19"	714	6x4

- Si-Mn forged steel jaw , high strength
- CR-Mo alloy steel plier body, keep the original style
- Adjustable better clamp size
- Circle head with cut function



BOLT CUTTER



H61100

H61101-H61108

EBS No.	Item No.	SIZE	pcs-case
1500882	H61100	8"	1 x 4
1500883	H61101	12"	1 x 4
1500884	H61102	14"	1 x 4
1500885	H61103	18"	1 x 4
1500886	H61104	24"	1 x 4
1500887	H61105	30"	1 x 4
1500888	H61106	36"	1 x 4
1500889	H61107	42"	1 x 2
1500890	H61108	48"	1 x 1

Replacement Bolt Cutter Head



EBS No.	Item No.	SIZE	pcs-case
1502517	H61121	12"	1 x 1
1502518	H61122	14"	1 x 1
1502519	H61123	18"	1 x 1
1502520	H61124	24"	1 x 1
1502521	H61125	30"	1 x 1
1502522	H61126	36"	1 x 1
1502523	H61127	48"	1 x 1

- PLS do not to cut HRC more than 35 CR-V
- ANSI B107.16M standard

Aviation Snip-10" Left



EBS No.	Item No.	SIZE	L(MM)	pcs-case
1502524	H61201	10"	250	6 x 6

- Max cutting 1.2MM cold steel or 0.7MM stainless
- Mad of CR-V, induction heated ,durable for impact
- Safety spring design to fix cutting area
- ANSI B107.16M standard

Aviation Snip-10" Right

1502525



EBS No.	Item No.	SIZE	L(MM)	pcs-case
1502525	H61202	10"	250	6 x 6

- Max cutting 1.2MM cold steel or 0.7MM stainless
- Mad of CR-V, induction heated ,durable for impact
- Safety spring design to fix cutting area
- ANSI B107.16M standard

Aviation Snip Center



EBS No.	Item No.	SIZE	L(MM)	pcs-case
1502526	H61203	10"	250	6 x 6
1502527	H61204	11"	275	6 x 6

- Max cutting 1.2MM cold steel or 0.7MM stainless
- Mad of CR-V, induction heated ,durable for impact
- Safety spring design to fix cutting area
- ANSI B107.16M standard

Tin Snip



EBS No.	Item No.	SIZE	L(MM)	pcs-case
1502528	H61301	8"	205	8 x 6
1502529	H61302	10"	263	6 x 6
1502530	H61303	12"	305	6 x 4
1502531	H61304	14"	356	6 x 4
1502532	H61305	16"	406	3 x 4

- Max cutting 1.2MM cold steel or 0.7MM stainless
- Mad of CR-V, induction heated ,durable for impact
- Safety spring design to fix cutting area
- ANSI B107.16M standard

Scissors



EBS No.	Item No.	SIZE	pcs-case
1502549	H61902	210MM	6 x 4

- Nylon injection handle, comfortable for use

Mini Hack Saw Handle-6"



EBS No.	Item No.	SIZE	pcs-case
1502593	H65100	6"(150MM)	1 x 24

- Nylon injection handle, comfortable for use

Aluminum Square Hack Saw Handle-12"



EBS No.	Item No.	SIZE	pcs-case
1502594	H65101	12"	1 x 24

- Include one saw
- Ergonomic designed handle, comfortable for using

3Pc Replacement Mini Hack Saw Blade Set-6"



EBS No.	Item No.	SIZE	pcs-case
1502598	H65201	6"	24x10

- 3pcs per SKU
- Better elastic, sharp, smoothly, malleable

12" Replacement Hack Saw Blade-18 Teeth Bi-Material Soft



EBS No.	Item No.	SIZE	pcs-case
1501359	H65205	18teeth	100x10
1501308	H65206	24teeth	100x10
1501309	H65207	32teeth	100x10

- High elastic with high speed steel teeth
- Hot forging, HRC63-66
- Could cut stainless, bearing steel, carbon steel and so on
- 1pcs per SKU

12" Replacement Hack Saw Blade-18 Teeth Bi-Material Soft



EBS No.	Item No.	SIZE	pcs-case
1501357	H65202	18teeth	100x10
1501358	H65203	24teeth	100x10
1502599	H65204	32teeth	100x10

- high-speed steel teeth, make the tech more elastic
- 1pcs per SKU

SNAP-OFF KNIFE



EBS No.	Item No.	SIZE	pcs-case
1500891	H61400	18(MM)	9 x 6

- ABS injection case, Stainless knife cover
- SK2 knife, deuable for impact

SNAP-OFF KNIFE



EBS No.	Item No.	SIZE	pcs-case
1500892	H61401	9(MM)	6 x 8

- Zinc alloy knife body, baking finish, stainless knife cover, durable for use
- SK2 knife, sharp, derable and long life

SNAP-OFF KNIFE



EBS No.	Item No.	SIZE	pcs-case
1500893	H61402	18(MM)	12 x 6

- Zinc alloy knife body, baking finish, stainless knife cover, durable for use
- SK2 knife, sharp, derable and long life

SNAP-OFF KNIFE



EBS No.	Item No.	SIZE	pcs-case
1500894	H61403	9(MM)	6 x 8

- ABS Injection, Stainless knife cover, durable for use
- SK2 knife, sharp, derable and long life

SNAP-OFF KNIFE



EBS No.	Item No.	SIZE	pcs-case
1500895	H61404	9(MM)	6 x 8

- Soft TPR mix ABS handle, stainless knife, comfortable for use
- Easy for knife changing, more security
- Professional knife store function, could store 5pcs 18mm knife
- Sharp with SK2 knife, durable for impact

SNAP-OFF KNIFE



EBS No.	Item No.	SIZE	pcs-case
1500896	H61405	9(MM)	9 x 6

- Soft TPR and ABS material, stainless knife, comfortable feel
- Easy for change knife, more security
- Professional knife store, could store 5pcs 9mm cutter, suitable for narrow space use
- SK2 knife, sharp, derable and long life

SNAP-OFF KNIFE



EBS No.	Item No.	SIZE	pcs-case
1500897	H61406	18(MM)	9 x 6

- Soft TPR mix ABS handle, Stainless knife, comfortable for use
- Locking designed rotary knife, for accurate cutting
- Sharp with SK2 knife, durable for impact

SNAP-OFF KNIFE



EBS No.	Item No.	SIZE	pcs-case
1500898	H61407	18(MM)	9 x 6

- Soft TPR and ABS material, stainless knife, comfortable feel
- Easy for change knife, more security
- Professional knife store, could store 5pcs 9mm cutter, suitable for narrow space use
- SK2 knife, sharp, derable and long life

10Pc Snap-off Utility Knife Blade-13 Seg. 9X80MM



EBS No.	Item No.	L(MM)	pcs-case
1502533	H61481	80	24x12

- Made with Japan S2 material, sharp, durable, increase 30% lifetime
- 10pcs per SKU, safety knife case, easy-using, finger-saving
- Suitable for Gem-Year H61501,H61502,H61503,H61504 knife*

Heavy Duty Utility Knife



EBS No.	Item No.	pcs-case
1502539	H61503	12 x 8

- kirsite knife, baking finish, gravity forward cenral for easy use
- Automatic knife, security for use
- pls use together with H61581,H91582, which can save 30% lifetime

10Pc Replacement Utility Knife Blade

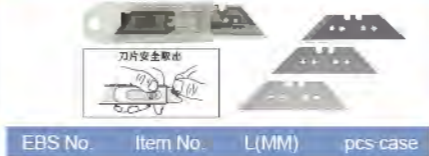

EBS No.	Item No.	L(MM)	pcs-case
1502541	H61581	80	24x12

- Made of Japan S2 updated material, Sharp, durable, increase 30% lifetime
- 10pcs per SKU, safety knife case, easy-using, finger-saving
- Suitable for Gem-Year H61501,H61502,H61503,H61504 knife

10Pc Snap-off Utility Knife Blade-8 Seg. 18X100MM

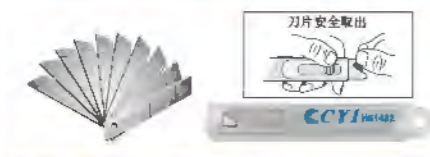

EBS No.	Item No.	L(MM)	pcs-case
1502534	H61482	100	24x12

- Made with Japan S2 material, sharp, durable, imcrease 30% lifetime
- 10pcs per SKU, safety knife case, easy-using, finger-saving
- Suitable for Gem-Year H61501,H61502,H61503,H61504 knife

Multi-Purpose Utility Knife



EBS No.	Item No.	pcs-case
1502540	H61504	12x12

- kirsite knife, baking finish, gravity forward cenral for easy use
- Automatic knife, security for use
- pls use together with H61581,H91582, which can save 30% lifetime

100Pc Replacement Utility Knife Blade

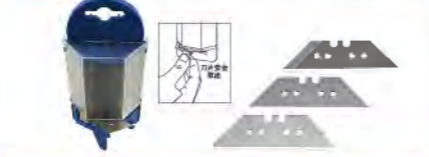

EBS No.	Item No.	L(MM)	pcs-case
1502542	H61582	80	6 x 8

- Made of Japan S2 updated material, Sharp, durable, increase 30% lifetime
- 10pcs per SKU, safety knife case, easy-using, finger-saving
- Suitable for Gem-Year H61501,H61502,H61503,H61504 knife

10Pc Snap-off Utility Knife Blade-8 Seg. 18X100MM(Simple)



EBS No.	Item No.	L(MM)	pcs-case
1502535	H61483	100	24x12

- Made with Japan S2 material, sharp, durable, imcrease 30% lifetime
- 10pcs per SKU, safety knife case, easy-using, finger-saving
- Suitable for Gem-Year H61501,H61502,H61503,H61504 knife

Utility Knife



EBS No.	Item No.	pcs-case
1502537	H61501	12 x 8

- kirsite knife, baking finish, gravity forward cenral for easy use
- Automatic knife, security for use
- pls use together with H61581,H91582, which can save 30% lifetime

H62501 1502586

5Pc Screw Extractor-Fine Teeth (5setx10Dcm)



- 5pcs Screw Extractor-Fine Teeth
- Made of CR-Mo, hot forging process
- quick remove break screw, tipe, bolt and hobnail

10Pc Snap-off Utility Knife Blade-14 Seg. 18X100MM(Simple)



EBS No.	Item No.	L(MM)	pcs-case
1502536	H61484	100	24x12

- Made with Japan S2 material, sharp, durable, imcrease 30% lifetime
- 10pcs per SKU, safety knife case, easy-using, finger-saving
- Suitable for Gem-Year H1400,H61402,H61405,H61406,H61407 knife

Safety Utility Knife



EBS No.	Item No.	pcs-case
1502538	H61502	12x12

- kirsite knife, baking finish, gravity forward cenral for easy use
- Automatic knife, security for use
- pls use together with H61581,H91582, which can save 30% lifetime

H62502 1502587

5Pc Screw Extractor-Rough Teeth (5setx10Dcm)



- Made with GCr 15 bearing steel, HRC57-60
- Quick remove breaked screw, convenient for use
- thin teeth design, long lifetime
- MMø3,3,5,3,6,4,8,8,11.2

High-Leverage Single Steel Riveter- 8"



EBS No.	Item No.	SIZE(MM)	pcs-case
1502662	H66001	8"	1 x 30

- Better mechanics design, comfortable feel, long life usage
- Equip with one small wrench, and C2.4,C3.2,C4.0,C4.8 rivet head
- Include 2.4/3.2/4.0/4.8 four rivets
- For metal, fibre, leatherette and other material weld

Pipe Cutter-6-64MM



EBS No.	Item No.	SIZE(MM)	pcs-case
1502545	H61603	6-64	1 x 4

- H61603 Used to cut 3-28MM pipe, plastic pipe
- pls ensure the claeen after use"

High Leverage Two Spout Hand Riveter



EBS No.	Item No.	SIZE(MM)	pcs-case
1502663	H66002	11"	1 x 20
1502664	H66003	13"	1 x 20

- Six point socket adjust working stroke
- Thicken handle with hot forging, for long time use
- 3pcs CR-Mo hot forging claw
- Convenient use

2Pc Pipe Cutter Replacement Blade-3X18MM



EBS No.	Item No.	SIZE(MM)	pcs-case
1501392	H61611	3.0x18MM	6 x 18

- Used for H61601 H61602and H61605 cut machine

Mini Pipe Cutter-3-16MM



EBS No.	Item No.	SIZE(MM)	pcs-case
1501391	H61604	3-16	6 x 8

- Used to cut 3-16MM pipe, plastic pipe
- Suitable for narrow space use

2Pc Pipe Cutter Replacement Blade-6.2X18MM,6.2X22MM



EBS No.	Item No.	SIZE(MM)	pcs-case
1501393	H61612	6.2x18MM,6.2x22MM	6 x 18

- Used for H61603 cut machine

Pipe Cutter



EBS No.	Item No.	SIZE(MM)	pcs-case
1502543	H61601	3-28	4 x 8
1502544	H61602	3-32	4 x 8

- H61601 Used to cut 3-28MM pipe, plastic pipe
- H61602 Used to cut 3-32MM pipe, plastic pipe
- pls ensure the claeen after use

PVC Pipe Cutter42MM



EBS No.	Item No.	SIZE(MM)	pcs-case
1501394	H61701	42	4 x 16

- Used to cut PVC pipe
- Heat treatment slainless knife, could extend the lifetime

H02812 5Pc Precision Slim Needle File Set-185MM

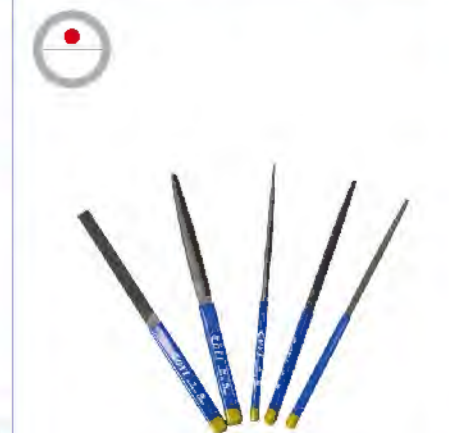

EBS No.	Item No.	SIZE(MM)	pcs-case
1501606	H02812	185	6 x 6

- Slim Flat File H65701 1502644
- Slim Half Round File H65711 1502649
- Slim Square File H65721 1502653
- Slim Round File H65731 1502656
- Slim Three Square File H65741 1502659

H02813 5Pc Precision Slim Needle File Set-200MM

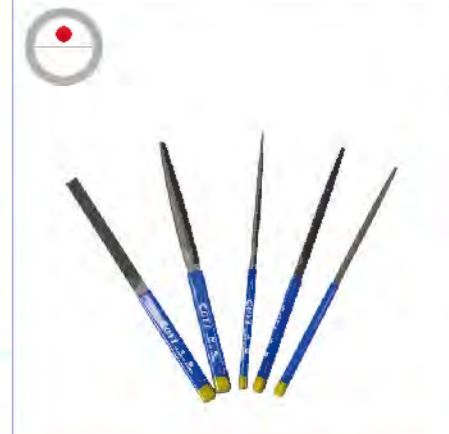

EBS No.	Item No.	SIZE(MM)	pcs-case
1501607	H02813	200	6 x 6

- Slim Flat File H65702 1502645
- Slim Half Round File H65712 1502650
- Slim Square File H65721 1502653
- Slim Round File H65731 1502656
- Slim Three Square File H65741 1502659

H02814

5Pc Precision Slim Needle File Set-215MM Fitter



EBS No.	Item No.	SIZE(MM)	pcs/case
1501608	H02814	215	6 x 6

- H65702 03924 Slim Flat File
- H65712 03944 Slim Half Round File
- H65721 03963 Slim Square File
- H65731 03975 Slim Round File
- H65741 03995 Slim Three Square File

H02815

3Pc Precision Slim Flat File Set



EBS No.	Item No.	pcs/case
1501609	H02815	6 x 6

- 1502645 H65702 Slim Flat File-200MM
- 1502646 H65703 Slim Flat File-215MM
- 1502647 H65704 Slim Flat File-185MM

Slim Flat File-185MM Second



EBS No.	Item No.	SIZE(MM)	pcs/case
---------	----------	----------	----------

- 1502644 H65701 185(second) 20 x 4
- 1502645 H65702 200 20 x 4
- 1502646 H65703 215 20 x 6
- 1502647 H65704 185(smooth) 20 x 4
- 1502649 H65711 185(second) 20 x 4
- 1502650 H65712 200 20 x 4
- 1502651 H65713 215 20 x 6
- 1502652 H65714 185(smooth) 20 x 4
- 1502653 H65721 185 20 x 4
- 1502654 H65722 200 20 x 4
- 1502655 H65723 215 20 x 6
- 1502656 H65731 185 20 x 4
- 1502657 H65732 200 20 x 4
- 1502658 H65733 215 20 x 6
- 1502659 H65741 185 20 x 4
- 1502660 H65742 200 20 x 4
- 1502661 H65743 215 20 x 6

● Imported for Japan

Flat File- Second



EBS No.	Item No.	SIZE	L (MM)	pcs/case
1502612	H65501	6"	270	8 x 6
1502613	H65502	8"	320	6 x 6
1502614	H65503	10"	370	4 x 6
1502615	H65504	12"	420	4 x 6

- Hardness higher steel file, include Mn, Cr elements
- Same appearance file, easy for quick filing
- Heat treatment file teeth, durable for impact
- Plastic handle for comfortable use
- GB/T5806-2003 and BS498:1960 Standard

Flat File- Smooth



EBS No.	Item No.	SIZE	L (MM)	pcs/case
1502632	H65601	6"	270	8 x 6
1502633	H65602	8"	320	6 x 6
1502634	H65603	10"	370	4 x 6
1502635	H65604	12"	420	4 x 6

- Hardness higher steel file, include Mn, Cr elements
- Same appearance file, easy for quick filing
- Heat treatment file teeth, durable for impact
- Plastic handle for comfortable use
- GB/T5806-2003 and BS498:1960 Standard

Half Round File-Bastard



EBS No.	Item No.	SIZE	L (MM)	pcs/case
1502604	H65411	6"	270	8 x 6
1502605	H65412	8"	320	6 x 6
1502606	H65413	10"	370	4 x 6
1502607	H65414	12"	420	4 x 6

- Hardness higher steel file, include Mn, Cr elements
- Same appearance file, easy for quick filing
- Heat treatment file teeth, durable for impact
- Plastic handle for comfortable use
- GB/T5806-2003 and BS498:1960 Standard

Half Round File- Second



EBS No.	Item No.	SIZE	L (MM)	pcs/case
1502616	H65511	6"	270	8 x 6
1502617	H65512	8"	320	6 x 6
1502618	H65513	10"	370	4 x 6
1502619	H65514	12"	420	4 x 6

- Hardness higher steel file, include Mn, Cr elements
- Same appearance file, easy for quick filing
- Heat treatment file teeth, durable for impact
- Plastic handle for comfortable use
- GB/T5806-2003 and BS498:1960 Standard

Square File-Bastard



EBS No.	Item No.	SIZE	L (MM)	pcs/case
1502608	H65421	6"	270	8 x 6
1502609	H65422	8"	320	6 x 6
1502610	H65423	10"	370	4 x 6
1502611	H65424	12"	420	4 x 6

- Hardness higher steel file, include Mn, Cr elements
- Same appearance file, easy for quick filing
- Heat treatment file teeth, durable for impact
- Plastic handle for comfortable use
- GB/T5806-2003 and BS498:1960 Standard

Square File-Second



EBS No.	Item No.	SIZE	L (MM)	pcs/case
1502620	H65521	6"	270	8 x 6
1502621	H65522	8"	320	6 x 6
1502622	H65523	10"	370	4 x 6
1502623	H65524	12"	420	4 x 6

- Hardness higher steel file, include Mn, Cr elements
- Same appearance file, easy for quick filing
- Heat treatment file teeth, durable for impact
- Plastic handle for comfortable use
- GB/T5806-2003 and BS498:1960 Standard

Round File-Second



EBS No.	Item No.	SIZE	L (MM)	pcs/case
1502624	H65531	6"	270	8 x 6
1502625	H65532	8"	320	6 x 6
1502626	H65533	10"	370	4 x 6
1502627	H65534	12"	420	4 x 6

- Hardness higher steel file, include Mn, Cr elements
- Same appearance file, easy for quick filing
- Heat treatment file teeth, durable for impact
- Plastic handle for comfortable use
- GB/T5806-2003 and BS498:1960 Standard

Three Square File-Second



EBS No.	Item No.	SIZE	L (MM)	pcs/case
1502628	H65541	6"	270	8 x 6
1502629	H65542	8"	320	6 x 6
1502630	H65543	10"	370	4 x 6
1502631	H65544	12"	420	4 x 6

- Hardness higher steel file, include Mn, Cr elements
- Same appearance file, easy for quick filing
- Heat treatment file teeth, durable for impact
- Plastic handle for comfortable use
- GB/T5806-2003 and BS498:1960 Standard

Fitter series

- Use hand file to cut the ordinary fitter file for hard working metal parts
- Different levels of the handle end are different:
 - Red : Coarse teeth
 - Yellow : In the teeth
 - Green : Serration

The file is forged with high hardness alloy steel, the shape of the file is uniform, the grinding is stable and fast and durable



Touch the plastic handle to the end of the different color difference file teeth grade

Flat File-Bastard



EBS No.	Item No.	SIZE	L (MM)	pcs/case
1502600	H65401	6"	270	8 x 6
1502601	H65402	8"	320	6 x 6
1502602	H65403	10"	370	4 x 6
1502603	H65404	12"	420	4 x 6

- Hardness higher steel file, include Mn, Cr elements
- Same appearance file, easy for quick filing
- Heat treatment file teeth, durable for impact
- Plastic handle for comfortable use
- GB/T5806-2003 and BS498:1960 Standard

Half Round File- Smooth



EBS No.	Item No.	SIZE	L (MM)	pcs/case
1502636	H65611	6"	270	8 x 6
1502637	H65612	8"	320	6 x 6
1502638	H65613	10"	370	4 x 6
1502639	H65614	12"	420	4 x 6

- Hardness higher steel file, include Mn, Cr elements
- Same appearance file, easy for quick filing
- Heat treatment file teeth, durable for impact
- Plastic handle for comfortable use
- GB/T5806-2003 and BS498:1960 Standard

Square File-Smooth



EBS No.	Item No.	SIZE	L (MM)	pcs/case
1502640	H65621	6"	270	8 x 6
1502641	H65622	8"	320	6 x 6
1502642	H65623	10"	370	4 x 6
1502643	H65624	12"	420	4 x 6

- Hardness higher steel file, include Mn, Cr elements
- Same appearance file, easy for quick filing
- Heat treatment file teeth, durable for impact
- Plastic handle for comfortable use
- GB/T5806-2003 and BS498:1960 Standard



H02801 **1501601**
 10Pc Precision Needle File Set-3X140MM Combination



EBS No.	Item No.	pcs-case
1501601	H02801	6 x 8

- Diameter:3*140MM
- Used for filing the component in samll tool case

Sharp	Description
	Flat File-Flat Point
	Half Round File-Sharp Point
	Square File-Sharp Point
	Three Square File-Sharp Point
	Round File-Sharp Point
	Round Double edge File-Sharp Point
	Knife File-Sharp Point
	Slim three File-Sharp Point
	Oblate File-Sharp Point
	Ellipse File-Sharp Point

H02802 **1501602**
 10Pc Precision Needle File Set-4X160MM Combination



EBS No.	Item No.	pcs-case
1501602	H02802	6 x 8

- Diameter:4*160MM
- Used for filing the component in samll tool case

Sharp	Description
	Flat File-Flat Point
	Half Round File-Sharp Point
	Square File-Sharp Point
	Three Square File-Sharp Point
	Round File-Sharp Point
	Round Double edge File-Sharp Point
	Knife File-Sharp Point
	Slim three File-Sharp Point
	Oblate File-Sharp Point
	Ellipse File-Sharp Point

H02803 **1501603**
 10Pc Precision Needle File Set-5X180MM Combination



EBS No.	Item No.	pcs-case
1501603	H02803	6 x 8

- Diameter:5*180MM
- Used for filing the component in samll tool case

Sharp	Description
	Flat File-Flat Point
	Half Round File-Sharp Point
	Square File-Sharp Point
	Three Square File-Sharp Point
	Round File-Sharp Point
	Round Double edge File-Sharp Point
	Knife File-Sharp Point
	Slim three File-Sharp Point
	Oblate File-Sharp Point
	Ellipse File-Sharp Point

H02806 **1501301**
 10Pc Precision Diamond Needle File Set-3X140MM Shaping



EBS No.	Item No.	pcs-case
1501301	H02806	6 x 8

- Diameter:3*140MM
- Working arrangemnet:50MM

Sharp	Description
	Flat File-Flat Point
	Half Round File-Sharp Point
	Square File-Sharp Point
	Three Square File-Sharp Point
	Round File-Sharp Point
	Round Double edge File-Sharp Point
	Knife File-Sharp Point
	Slim three File-Sharp Point
	Oblate File-Sharp Point
	Ellipse File-Sharp Point

H02804 **1501604**
 10Pc Precision Diamond Needle File Set-3X140MM Special Combination



EBS No.	Item No.	pcs-case
1501604	H02804	6 x 8

- Diameter:3*140MM
- Used for filing the component in samll tool case

H02805 **1501605**
 10Pc Precision Diamond Needle File Set-3X140MM Special Combination



EBS No.	Item No.	pcs-case
1501605	H02805	6 x 8

- Diameter:3*140MM
- Used for filing the component in samll tool case

H02807 **1501302**
 10Pc Precision Diamond Needle File Set-4X160MM Shaping



EBS No.	Item No.	pcs-case
1501302	H02807	10x4

- 4*160MM lenth handle diameter
- Working arrangement:50MM

Sharp	Description
	Flat File-Flat Point
	Half Round File-Sharp Point
	Square File-Sharp Point
	Three Square File-Sharp Point
	Round File-Sharp Point
	Round Double edge File-Sharp Point
	Knife File-Sharp Point
	Slim three File-Sharp Point
	Oblate File-Sharp Point
	Ellipse File-Sharp Point

Round Diamond File-3X140MM Sharp Point

Sharp Point



EBS No.	Item No.	pcs-case
1501319	H65303	10x50

- Made of #45 Steel, high efficiency with hardness man-made diamond plating
- Used for filing hard metal
- 3*140MM lenth handle diameter
- Working arrangement:50MM
- particle size:150

Flat Diamond File-3X140MM Flat Point

Flat Point



EBS No.	Item No.	pcs-case
1501317	H65301	10x50

- Made of #45 Steel, high efficiency with hardness man-made diamond plating
- Used for filing hard metal
- 4*160MM lenth handle diameter
- Working arrangement:50MM
- particle size:150

Half Round Diamond File-3X140MM Sharp Point

Sharp Point



EBS No.	Item No.	pcs-case
1501318	H65302	10x50

- Made of #45 Steel, high efficiency with hardness man-made diamond plating
- Used for filing hard metal
- 4*160MM lenth handle diameter
- Working arrangement:50MM
- particle size:150

Flat Diamond File-4X160MM Flat Point

Flat Point



EBS No.	Item No.	pcs-case
1501320	H65311	10x50

- Made of #45 Steel, high efficiency with hardness man-made diamond plating
- Used for filing hard metal
- 4*160MM lenth handle diameter
- Working arrangement:50MM
- particle size:150

Half Round Diamond File-4X160MM Sharp Point

Sharp Point



EBS No.	Item No.	pcs-case
1501321	H65312	10x50

- Made of #45 Steel, high efficiency with hardness man-made diamond plating
- Used for filing hard metal
- 4*160MM lenth handle diameter
- Working arrangement:50MM
- particle size:150

Round Diamond File-4X160MM Sharp Point

Sharp Point



EBS No.	Item No.	pcs-case
1501322	H65313	10x50

- Made of #45 Steel, high efficiency with hardness man-made diamond plating
- Used for filing hard metal
- 3*160MM lenth handle diameter
- Working arrangement:50MM
- particle size:150

H02808 **1501303**
 5Pc Precision Diamond Needle File Set-5X180MM Shaping



EBS No.	Item No.	pcs-case
1501303	H02808	10 x 4

Sharp	Description
	Flat File-Flat Point
	Half Round File-Sharp Point
	Square File-Sharp Point
	Three Square File-Sharp Point
	Round File-Sharp Point

- Made of #45 Steel, high efficiency with hardness man-made diamond plating
- Used for filing hard metal
- 4*160MM lenth handle diameter
- Working arrangement:50MM
- particle size:150

Flat Diamond File-5X180MM Flat Point

Flat Point



EBS No.	Item No.	pcs case
1501323	H65321	10x50

- Made of #45 Steel, high efficiency with hardness man-made diamond plating
- Used for filing hard metal
- 5*180MM lenth handle diameter
- Working arrangement:70MM
- particle size:150

Half Round Diamond File-5X180MM Sharp Point

Sharp Point



EBS No.	Item No.	pcs case
1501324	H65322	10x50

- Made of #45 Steel, high efficiency with hardness man-made diamond plating
- Used for filing hard metal
- 4*180MM lenth handle diameter
- Working arrangement:70MM
- particle size:150

Round Diamond File-5X180MM Sharp Point

Sharp Point



EBS No.	Item No.	pcs case
1501325	H65323	10x50

- Made of #45 Steel, high efficiency with hardness man-made diamond plating
- Used for filing hard metal
- 4*180MM lenth handle diameter
- Working arrangement:50MM
- particle size:150

H02809 1501304

3Pc Precision Diamond Needle File Set-3X140MM Shaping



EBS No.	Item No.	pcs case
1501304	H02809	10 x 4

Sharp	Description
	Flat File-Flat Point
	Half Round File-Sharp Point
	Square File-Sharp Point

- Made of #45 Steel, high efficiency with hardness man-made diamond plating,and for heat treatments tools use
- Used for filing hard metal
- 3*140MM lenth handle diameter
- Working arrangement:50MM
- particle size:150

H02810 1501305

3Pc Precision Diamond Needle File Set-4X160MM Shaping



EBS No.	Item No.	pcs case
1501305	H02810	10 x 4

Sharp	Description
	Flat File-Flat Point
	Half Round File-Sharp Point
	Square File-Sharp Point

- Made of #45 Steel, high efficiency with hardness man-made diamond plating,and for heat treatments tools use
- Used for filing hard metal
- 4*160MM lenth handle diameter
- Working arrangement:50MM
- particle size:150

H02811 1501328

3Pc Precision Diamond Needle File Set-5X180MM Shaping



EBS No.	Item No.	pcs case
1501328	H02811	10 x 4

Sharp	Description
	Flat File-Flat Point
	Half Round File-Sharp Point
	Square File-Sharp Point

- Made of #45 Steel, high efficiency with hardness man-made diamond plating,and for heat treatments tools use
- Used for filing hard metal
- 5*180MM lenth handle diameter
- Working arrangement:70MM
- particle size:150

Bi-Material Hole Saw



EBS No.	Item No.	SIZE(MM)	SIZE	pcs case
1502553	H62101	16	5/8"	20x10
1502554	H62102	19	3/4"	20x10
1502555	H62103	20	25/32"	20x10
1502556	H62104	22	7/8"	20x10
1502557	H62105	25	1"	20x10
1502558	H62106	30	1-3/16"	20x10
1502559	H62107	32	1-1/4"	12x10
1502560	H62108	35	1-3/8"	12x10
1502561	H62109	38	1-1/2"	12x10
1502562	H62110	44	1-3/4"	18x6
1502563	H62111	51	2"	18x6
1502564	H62112	57	2-1/4"	12x6
1502565	H62113	60	2-3/8"	12x6
1502566	H62114	64	2-1/2"	12x6

- Gem-year hole saw teeth made with high speed steel, HRC65-68, better cutting
- Speical Designed Teeth for eliminating, and improve working efficiency
- Accurate same heart level, uniform the strength, and increase the lifetime
- Used for cutting Wood, aluminum, brass, low carbon steel, Stainless
- Add cooling liquid before using

Hole Saw Mandrel-14-30MM



H62152



H62151

EBS No.	Item No.	mm	mm	pcs case
1502567	H62151	14-30	9.5	10x16
1502568	H62152	32-152	11.1	12x6

- Hole Saw Mandrel bar used to connect the hole saw mandrel and drill clip, and fix it in permanent position
- High-speed steel drill, HRC63-66
- Quick return spring, for easy take out

Hole Saw Pilot Drill-80MM



EBS No.	Item No.	SIZE(MM)	pcs case
1502569	H62201	80	32x20

- Made with high-speed steel, HRC63-66
- For 53401 and 53402 use only

H62303

5Pc normal edger trimmer



EBS No.	Item No.	pcs case
1502572	H62303	12x 8

- Used for trimming steel, stainless, aluminam and PP material
- Made with HSS,M2 high-speed steel,durable for cutting, HRC 65 for the knife
- 3.2MM knife diameter

H62302

1502571

3Pc edger trimmer



- Include one H62303 and one H62304 edger trimmer

H62301

1502570

2Pc Mini edger trimmer



- Include one H62303 edger trimmer

H62304

5Pc high strength edger trimmer



EBS No.	Item No.	pcs case
1502573	H62304	12x 8

- For almost all kinds of stainless tools working
- Made with HSS,M2 high-speed steel, include Co, durable for cutting, HRC 65 for the knife
- 3.2MM knife diameter

5Pc edger trimmer knife



EBS No.	Item No.	pcs-case
1502574	H62305	6 x 16

- Used for trimming steel, stainless, aluminam and PP material
- Made with S22 high-speed steel, knife HRC62-64HRC
- Knife diameter 3.2MM
- Better to use together with H62301 and H62302 handle

5Pc edger trimmer knife(plastic)



EBS No.	Item No.	pcs-case
1502575	H62306	6 x 16

- Used to trimming plastic material
- Could work in Diameter less than 1.5mm hole
- Made with HSS S2 high speed steel, HRC62-62 knife
- Knife diameter 3.2MM
- Better to use together with H62301 and H62302 handle

H62307 1502576

3Pc scraper set 6setx8case



- Technical handle:quick transfer knife head, for all kinds of hand style, adjsuable clip head for locking
- H62310 used to trimming all kinds of material, widely used in technical working and mould develop precess
- H62311 HSS high speed steel, used to trimming, scraping and cleaning the edger
- HRC62-64 knife, suitable for narrow space using, knife size:75*3.2MM

H62308 1502577

2Pc double-head adjustable triangle knife 6setx8case



- Technical handle:quick transfer knife head, for all kind of hand style, adjustable clip head for locking head length
- H62310 used for all kinds of material trimmer, especial technical process and mould develop, HRC58-60, knife size:80*4.5MM

H62309 1502578

2Pc mini adjustable knife 6setx8case



- Technical handle:quick transfer knife head, for all kind of hand style, adjustable clip head for locking head length
- H62310 used for all kinds of material trimmer, especial technical process and mould develop, HRC58-60, knife size:80*4.5MM

Double head Triangle Scraper-Mid-style



EBS No. Item No. pcs-case

1502579	H62310	12x 15
---------	--------	--------

- All kinds of tools and Casts Scraping, trimming and cleaning
- Widely used in Machining Operation and Mould Making
- Blade HRC:58-60HRC
- Knife Size:80*4.5MM

H62312 1502581

2Pc rotation driving set 6setx8case



- Use together with 93452 3pcs trimmer handle
- Use together with 93463 trimmer, for 0-16.5MM hole use, made with HSS high-speed steel
- Knife HRC62-64

Intra-annular edger head



EBS No. Item No. pcs-case

1502583	H62314	8 x 18
---------	--------	--------

- Could trim the width below 3mm "O" style notch
- Made with HSS high-speed steel, knife HRE62-64
- Use together with H62301 and H62302

HSS Teeth Bi-Material Small triangle Scraper



EBS No. Item No. pcs-case

1502580	H62311	8 x 18
---------	--------	--------

- Used for trimming all kinds of material
- Widely used intechanical process and mould develop,
- HRC62-64
- Knife size:75*3.2MM

Cank hole edger trimmer



EBS No. Item No. pcs-case

1502582	H62313	8 x 18
---------	--------	--------

- Used for 0-16.5 hold trime
- Made with HSS high-speed steel, knife HRE62-64
- Use together with H62301 and H62302

Rsmim edger trimmer



EBS No. Item No. pcs-case

1502584	H62315	8 x 18
---------	--------	--------

- Used for trimming 0-16.5 diameter hole
- Made with HSS high speed steel, HRC62-64 knife
- Better to use together with H62301 and H62302



Pry Bar-Bent Head



EBS No.	Item No.	SIZE	E(mm)	S(mm)	L(mm)	pcs case
1502351	H41101	18x400	22	18	400	4 x 6
1502352	H41102	20x600	24	20	600	4 x 4
1502353	H41103	22x800	26	22	800	4 x 2
1502354	H41104	22x1000	26	22	1000	4 x 2
1502355	H41105	25x1500	30	25	1500	2 x 2

- Made with imported CR-V steel
- Heat treatment, better hardness
- US ASME standard
- Corrosion resistance, beautiful surface

Gooseneck Wrecking Bar



EBS No.	Item No.	SIZE	E(mm)	S(mm)	L(mm)	pcs case
1502356	H41111	18x400	22	18	400	4 x 4
1502357	H41112	18x600	22	18	600	4 x 4
1502358	H41113	20x1000	24	20	1000	2 x 4

- Made with imported CR-V steel
- Heat treatment, better hardness
- US ASME standard
- Corrosion resistance, beautiful surface

H02701 1501597

5Pc Punch And Chisel Set (48set/cdn)



EBS No.	Item No.	SIZE
1502359	H41201	4X120MM
1502367	H41401	3X120MM
1502363	H41303	4X150MM
1502374	H41601	5X130MM
1502368	H41501	12X130MM

- Accurate size better than DIN stanard
- Security according to US ASME B107.47M-1998 and ASME B107.48.1998 standard
- Made with 60Cr-V steel
- Chrome plating, corrosion resistance

H02702 1501598

6Pc Punch And Chisel Set (24set/cdn)



EBS No.	Item No.	SIZE
1502361	H41301	2X150MM
1502362	H41302	3X150MM
1502363	H41303	4X150MM
1502364	H41304	5X150MM
1502365	H41305	6X150MM
1502366	H41306	8X150MM

- Accurate size better than DIN stanard
- Security according to US ASME B107.47M-1998 standard
- Made with 60Cr-V steel
- Chrome plating, corrosion resistance

H02704 1501600

13Pc Punch And Chisel Set (12set/cdn)



EBS No.	Item No.	SIZE
1502359	H41201	4x120MM
1502360	H41202	5x150MM
1502361	H41301	2x150MM
1502362	H41302	3x150MM
1502363	H41303	4x150MM
1502364	H41304	5x150MM
1502365	H41305	6x150MM
1502366	H41306	8x150MM
1502367	H41401	3x120MM
1502368	H41501	12x130MM
1502369	H41502	15x150MM
1502370	H41503	18x175MM
1502374	H41601	5x130MM

- Accurate size better than DIN stanard
- Security according to US ASME B107.47M-1998 and ASME B107.48.1998 standard
- Made with 60Cr-V steel
- Chrome plating, corrosion resistance

H02703 1501599

3Pc Chisel Set (8set/cdn)



EBS No.	Item No.	SIZE
1502371	H41504	20x200MM
1502372	H41505	22x250MM
1502373	H41506	25x300MM

- Accurate size better than DIN stanard
- Security according to US ASME B107.47M-1998 standard
- Made with 60Cr-V steel
- Chrome plating, prevent rusting

9Pc Number Stamp



EBS No.	Item No.	L(MM)	W(MM)	H (MM)	H (MM)	pcs case
1502375	H41800	7	7	60	3	10x10
1502376	H41801	7.5	7.5	60	4	5 x 10
1502377	H41802	8.8	8.8	63	5	5 x 10
1502378	H41803	10	10	65	6	5 x 10
1502379	H41804	12	12	69	8	5 x 4

- Beautiful words
- High HRC
- Baking Finish, corrosion resistance

27Pc Letter Stamp



EBS No.	Item No.	L(MM)	W(MM)	H (MM)	H (MM)	pcs case
1502380	H41805	7	7	60	3	5 x 6
1502381	H41806	7.5	7.5	60	4	5 x 4
1502382	H41807	8.8	8.8	63	5	5 x 4
1502383	H41808	10	10	65	6	3 x 4
1502384	H41809	12	12	69	8	2 x 4

- Beautiful words
- High HRC
- Baking Finish, corrosion resistance

CLAW HAMMER - FIBER GLASS



- High carbon steel hammer, durable for impact
- Fiberglass Handle, Good Feeling and toughness
- Special built-in Technical, Uneasy Fall off Hammer

Center Pin Punch



EBS No.	Item No.	A(MM)	B(mm)	L(mm)	pcs case
1502359	H41201	4mm	9.5	120	10 x 20
1502360	H41202	5mm	12	150	10 x 12

Regular Pin Punch

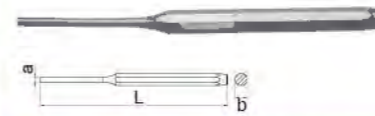

EBS No.	Item No.	A(MM)	B(mm)	L(mm)	pcs case
1502361	H41301	2mm	9.5	150	10 x 20
1502362	H41302	3mm	9.5	150	10 x 20
1502363	H41303	4mm	9.5	150	10 x 20
1502364	H41304	5mm	9.5	150	10 x 20
1502365	H41305	6mm	12	150	10 x 12
1502366	H41306	8mm	12	150	10 x 12

Prick Pin Punch



EBS No.	Item No.	A(MM)	B(mm)	L(mm)	pcs case
1502367	H41401	3mm	9.5	120	10 x 20

Cold Chisel-Flat



EBS No.	Item No.	A(MM)	B(mm)	L(mm)	pcs case
1502368	H41501	12mm	9.5	130	10 x 20
1502369	H41502	15mm	12	150	10 x 12
1502370	H41503	18mm	14	175	10 x 8

Cold Chisel-Flat



EBS No.	Item No.	A(MM)	B(mm)	L(mm)	pcs case
1502371	H41504	20mm	16	200	6 x 8
1502372	H41505	22mm	20	250	6 x 4
1502373	H41506	25mm	22	300	4 x 4

Cold Chisel-Diamond



EBS No.	Item No.	A(MM)	B(mm)	L(mm)	pcs case
1502374	H41601	5mm	9.5	130	10 x 20

CLAW HAMMER



EBS No.	Item No.	SIZE	L(mm)	pcs case
1502385	H44300	8oZ	247	4 x 6

- High carbon steel hammer, durable for impact

BALL PEIN HAMMER - FIBERGLASS



EBS No.	Item No.	SIZE	L(mm)	pcs case
1500827	H42200	16oZ	335	2 x 6
1500828	H42201	24oZ	390	2 x 8
1500829	H42202	32oZ	390	2 x 8

- Fiberglass Handle , Good Feeling and toughness
- Special built-in Technical,Uneasy Fall off

CLAW HAMMER - FIBERGLASS



EBS No.	Item No.	SIZE	L(mm)	pcs case
1500840	H44200	16oZ	330	2 x 8
1500841	H44201	24oZ	390	2 x 8

- High carbon steel hammer, durable for impact
- Fiberglass Handle , Good Feeling and toughness
- Special built-in Technical, Uneasy Fall off

BALL PEIN HAMMER - HICKORY HANDLE



EBS No.	Item No.	SIZE	L(mm)	pcs-case
1500823	H42100	8oz	290	4 x 9
1500824	H42101	16oz	336	2 x 6
1500825	H42102	24oz	356	2 x 6
1500826	H42103	32oz	376	2 x 6

- High carbon steel hammer durable for impact
- American hickory Handle, Good Feeling and toughness
- Special built-in Technical Uneasy Fall off

CLAW HAMMER - HICKORY HANDLE

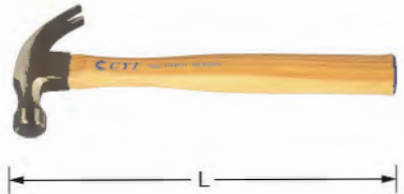

EBS No.	Item No.	SIZE	L(mm)	pcs-case
1500836	H44100	7oz	275	4 x 9
1500837	H44101	13oz	308	2 x 6
1500838	H44102	16oz	330	2 x 6
1500839	H44104	24oz	338	2 x 6

- High carbon steel hammer, durable for impact
- American hickory Handle, Good Feeling and toughness
- Special built-in Technical, Uneasy Fall off

ENGINEERS HAMMER - HICKORY HANDLE



EBS No.	Item No.	SIZE	L(mm)	pcs-case
1500830	H43100	200G	285	4 x 6
1500831	H43101	300G	300	4 x 6
1500832	H43102	400G	320	2 x 6
1500833	H43103	500G	320	2 x 6
1500834	H43104	800G	350	2 x 8
1500835	H43105	1000G	360	2 x 8

- High carbon steel hammer, durable for impact
- American hickory Handle, Good Feeling and toughness
- Special built-in Technical, Uneasy Fall off

Copper Hammer, Hickory Handle



EBS No.	Item No.	SIZE	L(mm)	pcs-case
1503051	H42111	1LB	304	4 x 4
1503052	H42112	2LB	324	4 x 4
1503050	H42113	3LB	334	4 x 4

Dead Blow Hammer



EBS No.	Item No.	SIZE	L(mm)	pcs-case
1502387	H46000	14oz(400g)	260	2 x 6
1502388	H46001	18oz(520g)	286	2 x 9
1502389	H46002	37oz(1050g)	350	2 x 6
1502390	H46003	53oz(1500g)	370	2 x 6

- Technical SBR material, durable for knocking, prevent slip, prevent oil, comfortable feel
- Could press knocking, not influence the tool surface

SOFT FACE - HICKORY HANDLE



EBS No.	Item No.	DIA(mm)	L(mm)	WT(g)	pcs-case
1500842	H45100	22	260	160	6 x 9
1500843	H45101	28	300	162	4 x 9
1500844	H45102	35	320	308	2 x 9
1502386	H45100	45	320	454	2 x 6
1500845	H45104	60	385	778	2 x 8

- High quality Aluminum Steel Hammer Head
- Changeable Hard and Soft Hammer Head
- For different occasion use
- Changeable plastic Hammer Head

Interchangeable Hammer Tip-Soft Face



EBS No.	Item No.	L(mm)	pcs-case
1502391	H47001	22	6 x 48
1502392	H47002	28	6 x 36
1502393	H47003	35	8 x 18
1502394	H47004	45	6 x 18
1502395	H47005	60	6 x 8

- For knocking plastic, soft lead, wood, brass and soft metal
- The HRC of the hammer is same as the surface, which can protect the surface well
- Not break or Deformation
- For install industrial use

Interchangeable Hammer Tip-Hard Face



EBS No.	Item No.	L(mm)	pcs-case
1502396	H47011	22	6 x 48
1502397	H47012	28	6 x 36
1502398	H47013	35	8 x 18
1502399	H47014	45	6 x 18
1502400	H47015	60	6 x 8

- For knocking plastic, soft lead, wood, brass and soft metal
- The HRC of the hammer is same as the surface, which can protect the surface well
- Not break or Deformation
- For install industrial use



TAPE MEASURE



EBS No.	Item No.	SIZE(MM)	L(mm)	pcs	case
1502680	H71100	2M	16	12	X 10
1502681	H71101	3M	16	12	X 10
1502682	H71102	5M	19	12	X 10
1502683	H71103	5M	25	6	X 10
1502684	H71104	7.5M	25	6	X 10
1503049	H71105	10M	25	6	X 10

- High quality steel, Matte painting finish, high force spring design
- ABS Ruler Shell
- Ruler Hook Automatic return to zero design, ensure measurement start from Zero

Metric Steel Tape



EBS No.	Item No.	SIZE(MM)	L(mm)	pcs	case
1504050	H71152	3M	16	12	X 10
1504051	H71154	5M	19	12	X 10
1504052	H71157	7.5M	25	6	X 10

- High quality steel, high force spring design
- ABS Ruler Shell
- Ruler Hook Automatic return to zero design, ensure measurement start from Zero

Box Beam Level



EBS No.	Item No.	SIZE	L(MM)	pcs	case
1502724	H73001	12"	300	10	X 6
1502725	H73002	18"	450	10	X 6
1502726	H73003	24"	600	10	X 6
1502727	H73004	30"	750	10	X 3
1502728	H73005	36"	900	10	X 3
1502729	H73006	48"	1200	10	X 3

- CNC machining cavity for Vials in levels
- Machined bottom to ensure perfect straight
- High quality thicken square vials
- Square vials with enlarge function
- long lifestyle UV protection vials

H72001 1502720

Feeler Gauge Set 14Pc-0.05-1.00MM (24set/ctn)



- Made with 65#Mn, full polish surface, surface polish finish
- 3" ruler, include 2" straightedge
- Specification: (0.05,0.10,0.15,0.20,0.25,0.30,0.40,0.50,0.60,0.70,0.80,0.90,1.00MM)
- DIN 2275 and JIS B 7524-1992 standard

H72002 1502721

Feeler Gauge Set 16Pc-0.05-1.00MM (12set/ctn)

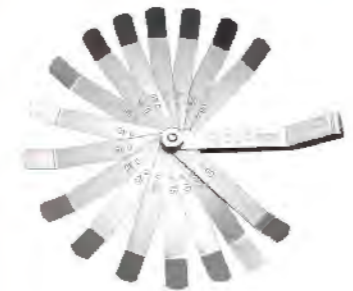

- Made with 65#Mn, full polish surface, surface polish finish
- 3" ruler, include 2" straightedge
- Specification: (0.05,0.10,0.15,0.20,0.25,0.30,0.40,0.50,0.55,0.60,0.70,0.75,0.80,0.90,1.00MM)
- DIN 2275 and JIS B 7524-1992 standard

Stainless Ruler-150MM



EBS No.	Item No.	SIZE(MM)	pcs	case
1502730	H74100	150	12	X 12
1502731	H74101	300	12	X 9
1502732	H74102	500	10	X 9
1502733	H74103	1000	10	X 4

- Made of Stainless
- GB Standard, clearly word, durable for use

H72003 1502722

Feeler Gauge Set 16Pc-0.05-1.00MM (36set/ctn)



- Made with 65#Mn, full polish surface, surface polish finish
- 3" ruler, include 2" straightedge
- Specification: (0.05,0.10,0.15,0.20,0.25,0.30,0.40,0.50,0.55,0.60,0.70,0.75,0.80,0.90,1.00MM)
- DIN 2275 and JIS B 7524-1992 standard

H72004 1502723

Feeler Gauge Set 32Pc-0.02-1.00MM (36set/ctn)



- Made with 65#Mn, full polish surface, surface polish finish
- 3.5" ruler
- Specification: (0.02,0.03,0.04,0.05,0.06,0.07,0.08,0.09,0.10,0.13,0.15,0.18,0.20,0.23,0.25,0.28,0.30,0.33,0.38,0.40,0.45,0.50,0.55,0.60,0.63,0.65,0.70,0.75,0.80,0.85,0.90,1.00MM)

Try Square-200MM Stainless Blade & Aluminum Handel



EBS No.	Item No.	SIZE(MM)	pcs	case
1502734	H74200	200	10	X 4
1502735	H74201	300	10	X 4

- Made of Stainless
- GB Standard, clearly word, durable for use

*Please read the pages of this page after all the products have been sold out

Vernier Caliper-0-150MM



EBS No.	Item No.	Range	Minute	Precision	pcscase
1501331	H75101	0-150	0.02	±0.03	6 x 6

- Measurement :0-150MM
- Made of Stainless, high accurate measure
- Used for inner hole and out circle

Digital Caliper-0-150MM



EBS No.	Item No.	Range	Minute	Precision	pcscase
1501333	H75201	0-150	0.01	±0.03	6 x 6

- Measurement :0-150MM
- 3 button measurement, made of stainless, accurate measurement
- With battery power button, change MM/INCH freely
- RS233 ooutput

Dial Caliper-0-150MM



EBS No.	Item No.	Range	Minute	Precision	pcscase
1501338	H75301	0-150	0.02	±0.03	6 x 6

- Measurement :0-150MM
- Made of stainless, accurate measurement
- Shockproof function
- Out ring lock function

Outside Micrometer-0-25MM



EBS No.	Item No.	Range	Minute	Precision	pcscase
1501335	H76001	0-25	0.01	±0.004	6 x 6

- Measurement :0-25MM
- Hard alloy surface, durable for grind
- With detect power device, make the measurement more accurate
- With micrometer locking device

Vernier Caliper-0-200MM



EBS No.	Item No.	Range	Minute	Precision	pcscase
1501332	H75102	0-200	0.02	±0.03	6 x 6

- Measurement :0-200MM
- Made of Stainless, high accurate measure
- Used for inner hole and out circle

Digital Caliper-0-200MM



EBS No.	Item No.	Range	Minute	Precision	pcscase
1501334	H75202	0-200	0.01	±0.03	6 x 6

- Measurement :0-200MM
- 3 button measurement, made of stainless, accurate measurement
- With battery power button, change MM/INCH freely
- RS233 ooutput

Dial Caliper-0-200MM



EBS No.	Item No.	Range	Minute	Precision	pcscase
1501339	H75302	0-200	0.02	±0.03	6 x 6

- Measurement :0-200MM
- Made of stainless, accurate measurement
- Shockproof function
- Out ring lock function

Outside Micrometer-25-50MM



EBS No.	Item No.	Range	Minute	Precision	pcscase
1501341	H76002	25-50	0.01	±0.004	6 x 6

- Measurement :25-50MM
- Hard alloy surface, durable for grind
- With detect power device, make the measurement more accurate
- With micrometer locking device

Vernier Caliper-0-300MM



EBS No.	Item No.	Range	Minute	Precision	pcscase
1501336	H75103	0-300	0.02	±0.03	6 x 6

- Measurement :0-300MM
- Made of Stainless, high accurate measure
- Used for inner hole and out circle

Digital Caliper-0-300MM



EBS No.	Item No.	Range	Minute	Precision	pcscase
1501337	H75203	0-300	0.01	±0.03	5 x 4

- Measurement :0-300MM
- 3 button measurement, made of stainless, accurate measurement
- With battery power button, change MM/INCH freely
- RS233 ooutput

Dial Caliper-0-300MM



EBS No.	Item No.	Range	Minute	Precision	pcscase
1501340	H75303	0-300	0.02	±0.03	5 x 4

- Measurement :0-300MM
- Made of stainless, accurate measurement
- Shockproof function
- Out ring lock function

Outside Micrometer-50-75MM



EBS No.	Item No.	Range	Minute	Precision	pcscase
1501342	H76003	50-75	0.01	±0.005	6 x 6

- Measurement :50-75MM
- Hard alloy surface, durable for grind
- With detect power device, make the measurement more accurate
- With micrometer locking device

Vernier Caliper-0-150MM



NEW

EBS No.	Item No.	Range	Minute	Precision	pcscase
2204590	H75104	0-150	0.02	±0.03	6 x 6

- Measurement :0-150MM
- Made of Stainless, high accurate measure
- Used for inner hole and out circle
- The packaging is upgraded to high quality ABS new plastic box

Vernier Caliper-0-200MM



NEW

EBS No.	Item No.	Range	Minute	Precision	pcscase
2204591	H75105	0-200	0.02	±0.03	6 x 6

- Measurement :0-200MM
- Made of Stainless, high accurate measure
- Used for inner hole and out circle
- The packaging is upgraded to high quality ABS new plastic box

Vernier Caliper-0-300MM



NEW

EBS No.	Item No.	Range	Minute	Precision	pcscase
2204592	H75106	0-300	0.02	±0.03	6 x 6

- Measurement :0-300MM
- Made of Stainless, high accurate measure
- Used for inner hole and out circle
- The packaging is upgraded to high quality ABS new plastic box

Digital Caliper-0-150MM



NEW

EBS No.	Item No.	Range	Minute	Precision	pcscase
2204593	H75204	0-150	0.01	±0.03	6 x 6

- Measurement :0-150MM
- 3 button measurement, made of stainless, accurate measurement
- With battery power button, change MM/INCH freely
- RS233C output
- The packaging is upgraded to high quality ABS new plastic box

Digital Caliper-0-200MM



NEW

EBS No.	Item No.	Range	Minute	Precision	pcscase
2204594	H75205	0-200	0.01	±0.03	6 x 6

- Measurement :0-200MM
- 3 button measurement, made of stainless, accurate measurement
- With battery power button, change MM/INCH freely
- RS233C output
- The packaging is upgraded to high quality ABS new plastic box

Digital Caliper-0-300MM



NEW

EBS No.	Item No.	Range	Minute	Precision	pcscase
2204595	H75206	0-300	0.01	±0.03	5 x 4

- Measurement :0-300MM
- 3 button measurement, made of stainless, accurate measurement
- With battery power button, change MM/INCH freely
- RS233C output
- The packaging is upgraded to high quality ABS new plastic box

Dial Caliper-0-150MM



NEW

EBS No.	Item No.	Range	Minute	Precision	pcscase
2204596	H75304	0-150	0.02	±0.03	6 x 6

- Measurement :0-150MM
- Made of stainless, accurate measurement
- Shockproof function
- Out ring lock function

Dial Caliper-0-200MM



NEW

EBS No.	Item No.	Range	Minute	Precision	pcscase
2204597	H75305	0-200	0.02	±0.03	6 x 6

- Measurement :0-200MM
- Made of stainless, accurate measurement
- Shockproof function
- Out ring lock function

Dial Caliper-0-300MM



NEW

EBS No.	Item No.	Range	Minute	Precision	pcscase
2204598	H75306	0-300	0.02	±0.03	5 x 4

- Measurement :0-300MM
- Made of stainless, accurate measurement
- Shockproof function
- Out ring lock function

Outside Micrometer-0-25MM



NEW

EBS No.	Item No.	Range	Minute	Precision	pcscase
2204599	H76004	0-25	0.01	±0.004	6 x 6

- Measurement :0-25MM
- Hard alloy surface, durable for grind
- With detect power device, make the measurement more accurate
- With micrometer locking device
- The packaging is upgraded to high quality ABS new plastic box

Outside Micrometer-25-50MM



NEW

EBS No.	Item No.	Range	Minute	Precision	pcscase
2204600	H76005	25-50	0.01	±0.004	6 x 6

- Measurement :25-50MM
- Hard alloy surface, durable for grind
- With detect power device, make the measurement more accurate
- With micrometer locking device
- The packaging is upgraded to high quality ABS new plastic box

Outside Micrometer-50-75MM



NEW

EBS No.	Item No.	Range	Minute	Precision	pcscase
2204601	H76006	50-75	0.01	±0.005	6 x 6

- Measurement :50-75MM
- Hard alloy surface, durable for grind
- With detect power device, make the measurement more accurate
- With micrometer locking device
- The packaging is upgraded to high quality ABS new plastic box





H01000 1500003
13PCS. ELECTRONIC TOOL SET (12set/ctn)



DESCRIPTION:

- Mini Long Nose Plier 5"
- Mini Ature Diagonal Plier 4"
- Screwdrivers Slotted 3.2x75mm
- Screwdrivers Slotted 5x75mm
- Screwdriver Phillips PH1x75mm
- Screwdriver Phillips PH0x75mm
- Long Life Sopldering Iron 30w
- Solder Wire 17g
- Solder Iron Stand
- Fine Point Tweezer 125 mm
- Electronician's Scissors 138 mm
- Detecting Screwdriver 145 mm
- Solder Absorber

H01001 1500004
19PCS. ELECTRONIC TOOL SET (8set/ctn)



DESCRIPTION:

- Adjustable Wrenches 6"
- Screwdriver Phillips PH1x75mm
- Screwdriver Phillips PH2x100mm
- Screwdriver Phillips PH0x75mm
- Screwdrivers Slotted 5x75mm
- Screwdrivers Slotted 6x100mm
- Screwdrivers Slotted 3x75mm
- Detecting Screwdriver 220v
- Long Nose Precision Plier 5"
- Long Life Sopldering Iron 30w
- Solder Iron Stand
- Solder Wire 17g
- Solder Absorber 4"
- Mini Diagonal Cuttingprecision Plier 4"
- Cutting Knife 9mm
- Adjustable Wrist Strap 3m
- Fine Point Tweezer 125 mm
- Wire Strippers With Esd Plastic Handle 150 mm
- Anti-static Brush 175 mm

H01002 1500005
27PCS. ELECTRONIC TOOL SET (8set/ctn)



DESCRIPTION:

- Adjustable Wrenches 6"
- Screwdriver Phillips PH2x38mm ,
- PH0x75mm ,PH1x100mm
- Screwdriver Slotted 6x38mm ,
- 3.2x75mm ,5x100mm
- Detecting Screwdriver 220v
- Mini Long Nose Plier 5"
- Mini Ature Diagonal Plier 4"
- Long Life Sopldering Iron 30w
- Solder Wire 17g
- Solder Absorber 4"
- Electrician's Knife
- Fine Point Tweeze 125mm
- Adjustable Wrist Strap 3m
- Anti-static Brush 175mm
- Tape Measure 3mx16mm
- Hex Key (Metric) 1.5 ,2.0,2.5,3.0,4.0,5.0,6.0mm
- Multi-functional Stripper 210mm
- Solder Iron Stand

H01023 1501490
8Pc Electronic Tool Set (12set/ctn)



DESCRIPTION:

- 1pcs slot screwdriver-plastic handle (5*75MM)
- 1pcs phillips screwdriver-plastic handle (PH1*75MM)
- 1pcs mini long nose plier-5"
- 1pcs mini Diagonal Pliers-4"
- 1pcs Wire Stripping/Cutting Pliers-6"
- 6pcs mini screwdriver
- 1pcs Tweezer-125MM Sharp Point
- 1pcs Electronic Snip-138MM
- Bag Case: 245*160*35MM
- The bag material didn't waterproof, pls store in security suitation to prevent damage

H01024 1501491
23Pc Electronic Maintenance Tool Set (6set/ctn)



- 1pcs Adjustable Wrench-6", Cusion Grip
- 2pcs screwdriver-plastic handle(5*75MM, 6*75MM)
- 3pcs slot screwdriver-plastic handle(3*75MM, 5*75MM)
- 4pcs phillips screwdriver-plastic handle(PH0*75MM, PH1*75MM, PH2*100MM, PH2*150MM)
- 1pcs Long Nose Pliers-6"
- 1pcs Diagonal Pliers-5"
- 1pcs Lineman's Pliers-6"
- 1pcs Slim Flat File-185MM
- 1pcs Slim Half Round File-185MM
- 1pcs Tweezer-125MM Sharp Point
- 1pcs Long Life External Heating Soldering Tip-30W
- 1pcs solder socket
- 1pcs tip holder
- 1pcs Solder-1.0MM/17g Bar
- 1pcs Digital Detecting Screwdriver
- 1pcs Aluminum Flashlight-Two 5# Battery

- For factory basic electric use,
- Include waterproof polyester zipper bag, easy to take"

H01011 1500014
53PCS. ELECTRONIC TOOL SET (2set/ctn)



DESCRIPTION:

- 11-1/4"Dr. 6pt. Sockets 4,5,5.5,6,7,8,9,10,11,12,13mm
- 15-1/4"Dr. Bit Sockets Slotted 4,5,5.5,6.5mm Phillips #1,#2,#3 Torx T-10,T-15,T-20 Hex 2,2.5,3,4,5,6mm
- 4-Screwdrivers Phillips #1x75mm,#2x200mm,
- Slotted 5x75mm,6x100mm
- 6-Precision Screwdrivers Phillips #0x75mm, #0x100mm,#1x150mm Slotted 2x75mm,3x100mm,4x150mm
- 17-Accessories
- 1/4"Dr. Bit Adapter 25mm
- Bit Screwdriver With Magnet
- Detecting Screwdriver
- Long Nose Pliers 6"
- Diagonal Pliers 6"
- Electrician's Knife
- Long Life Soldering Iron 30w
- Mini Stand For Soldering Iron
- Anti-static Brush
- Solder Absorber
- Insulated Tape
- Adjustable Wrench/dipping Grip 6"
- Solder Wire 1.0mm / 17g
- Aluminum Flashlights
- Self Adjusting Cutter Stripper 6-1/2"
- Measure Tape 3m x 16mm



H01015 1501483

56Pc Electronic Maintenance Tool Set (2set/cdn)



- 8pcs foldable hex key
- 1pcs digital Detecting Screwdriver
- 1pcs plastic holder Utility Knife
- 1pcs Aluminum Flashlight-One 7# Battery
- 3pcs slot screwdriver(6*38,3*75,5*100MM)
- 3pcs phillips screwdriver(PH0*75,PH1*100,PH2*150)
- 6pcs mini multi-usage screwdriver set
- 1pcs Wire Stripping Pliers-B Type Heavy Duty
- 1pcs Adjustable wrench-8"
- 13pcs 6.3MM socket-6 point (4,4.5,5,5.5,6,7,8,9,10,11,12,13,14MM)
- 1pcs Long Nose Pliers-6"
- 1pcs Diagonal Pliers-6"
- 1pcs Lineman's Pliers-8"
- 3pcs 6.3MM long slot socket bit-25MM (4,5,5.6,5MM)
- 3pcs 6.3MM long phillips socket bit-25MM (PH1,PH2,PH3)
- 3pcs 6.3MM long star socket bit-25MM (T10,T15,T20)
- 1pcs 6.3MM bit driver
- 1pcs 6.3MM bit holder
- 1pcs External Heating Soldering Tip-30W
- 1pcs tip holder
- 1pcs Solder Sucker-Plastic
- 1pcs 3*160 Measuring Tape
- 1pcs Solder
- 1pcs VDE Insulated tape
- 1pcs Anti-Static Brush
- 1pcs Tweezer- Sharp Point
- 1pcs plastic compenents case

H02211 1501540

16Pc 10MM Dr VDE Insulated Socket set (6set/cdn)



- 8pcs 10MM socket-6 point (8,10,12,13,14,17,19,22MM)
- 1pcs 10MM quick-lease ratchet-200MM
- 1pcs 10MM T-Handle-200MM
- 1pcs 10MM extension bar-150MM
- 1pcs 10MM extension bar-250MM
- 4pcs 10MM bit socket-6 point(4,5,6,8MM)
- VDE Requirements
- VDE and DIN EN/TEC60900-2004 standard
- 100% meets 10000V testing, high voltage 1000V
- Security for use, VDE testing, resistance testing and hardness testing
- High and low temperature testing, lowest -40°C temperature

H02212 1501541

20Pc 12.5MM Dr VDE Insulated Socket Set(6set/cdn)



- 11pcs 12.5MM socket-6 point(10,11,12,13,14,17,19,22,24,27,32MM)
- 1pcs 12.5MM quick-lease ratchet-250MM
- 1pcs 12.5MM T-Handle-200MM
- 1pcs 12.5MM extension bar-125MM
- 1pcs 12.5MM extension bar-250MM
- 5pcs 10MM bit socket-6 point(4,5,6,8,10MM)
- VDE Requirements
- VDE and DIN EN/TEC60900-2004 standard
- 100% meets 10000V testing, high voltage 1000V
- Security for use, VDE testing, resistance testing and hardness testing
- High and low temperature testing, lowest -40°C temperature

Diagonal Pliers, Anti-Static Grip



EBS No.	Item No.	L(MM)	SIZE(MM)	pcs-case
1502419	H50100	125	2.5	4 x 8

- Anti-static handle, used for anti-static environment
- Max Cutting thread: ø1.3MM
- Thin Cutting knife
- Please do not cut steel or metal

Diagonal Pliers, Enhanced Anti-Static Grip



EBS No.	Item No.	L(MM)	SIZE(MM)	pcs-case
1502420	H50101	125	30.0	4 x 8

- Anti-static handle, used for anti-static environment
- Max Cutting thread: ø1.3MM
- Thin Cutting knife
- Please do not cut steel or metal

Diagonal Pliers, Anti-Static Grip



EBS No.	Item No.	L(MM)	SIZE(MM)	pcs-case
1502421	H50102	125	25.0	4 x 8

- Anti-static handle, used for anti-static environment
- Max Cutting thread: ø1.3MM
- Thin Cutting knife
- Please do not cut steel or metal

Long Nose Pliers, Anti-Static Grip



EBS No.	Item No.	L(MM)	pcs-case
1502422	H50103	150	4 x 8

- Anti-static handle, used for anti-static environment

Flat Long Nose Pliers, Anti-Static Grip



EBS No.	Item No.	L(MM)	pcs-case
1502423	H50104	150	4 x 8

- Anti-static handle, used for anti-static environment

Electronic Long Nose Pliers, Anti-Static Grip



EBS No.	Item No.	L(MM)	pcs-case
1502424	H50105	150	4 x 8

- Anti-static handle, used for anti-static environment

Flush Cutter Diagonal Pliers



EBS No.	Item No.	L(MM)	pcs-case
1502447	H50701	5"	6 x 6
1502448	H50702	6"	6 x 6
1502449	H50703	7"	6 x 6

- Made of 60CR-V, HRC43-48,

Cable Cutter



EBS No.	Item No.	L(MM)	SIZE(MM)	pcs-case
1501431	H50301	150	6"	6 x 10
1501432	H50302	200	8"	6 x 10
1501433	H50303	250	10"	6 x 6

Wire Stripping Pliers, Multi-Purpose



EBS No.	Item No.	L	pcs-case
1502427	H50200	6.5"	6 x 9

- Stripping Arrangement: 0.5-6.0MM diameter since wire or flat cable
- Attention: for first time use, pls take care of the plier mouth, in order to prevent the core wire damage

Wire Stripping/Cutting Pliers



EBS No.	Item No.	L(MM)	pcs-case
1502428	H50201	6"	6 x 8
1502429	H50202	7"	10 x 6

- Wire Stripping Arrangement:
H50201 20-30AWG 0.52-0.00MM²
H50202 10-22AWG 0.32-5.26MM²

Wire Stripping Pliers, Anti-Static Grip



EBS No.	Item No.	L(MM)	SIZE	pcs-case
1502425	H50106	150	0.8~2.6MM²	4 x 8
1502426	H50107	150	0.2~0.8MM²	4 x 8

- Anti-static handle, used for anti-static environment

Wire Stripping Pliers-A Type Heavy Duty



EBS No.	Item No.	L(MM)	SIZE	pcs-case
1502430	H50203	7"	Ø0.5,1.2,1.6,2	6 x 8

- Provide accurate pull wire function, protect the guide line
- Pelier mouth open and colse freely, convenient hand use
- QB/T2207-1996 Standard

Wire Stripping Pliers-B Type Heavy Duty



EBS No.	Item No.	L(MM)	SIZE	pcs-case
1502431	H50204	7"	Ø1,1.6,2,6,3,2	6 x 8

- Provide accurate pull wire function, protect the guide line
- Pelier mouth open and colse freely, convenient for hand using
- QB/T2207-1996 Standard

VDE Insulated Skinning Knife- Hawbill, Anti-Damang



EBS No.	Item No.	pcs-case
1502514	H61010	6 x 4

- VDE certified per DIN EN/TEC60900-2004 standard
- 100% meets 10000V testing, high voltage 1000V
- bend knife design, prevent damage
- Suitable for electric and similar industry use
- Human mechanical property, comfortable for use

VDE Insulated Skinning Knife- Hawbil



EBS No.	Item No.	pcs-case
1502515	H61011	6 x 4

- VDE certified per DIN EN/TEC60900-2004 standard
- 100% meets 10000V testing, high voltage 1000V
- Suitable for electric and similar industry use
- Human mechanical property, comfortable for use

VDE Insulated Skinning Knife- Straight



EBS No.	Item No.	pcs-case
1502516	H61012	6 x 4

- VDE certified per DIN EN/TEC60900-2004 standard
- 100% meets 10000V testing, high voltage 1000V
- Suitable for electric and similar industry use
- Human mechanical property, comfortable for use

Folding Electronic Knife-70MM Straight, Wood Handle



EBS No.	Item No.	pcs-case
1500881	H61000	20 x 2

- Made with special hard Mn steel, better Toughness
- knife hard higher than 52HRC
- Imported palisander handle, durable for impact
- pls keep the knife neatly after use
- pls don't store in salt suitation to prevent corrosion resistance
- For long time using, pls painting corrosive oil to portect
- NO VDE function
- pls don't knocking, otherwise the handle will break

Folding Electronic Knife-70MM Hawbill, Wood Handle



EBS No.	Item No.	pcs-case
1502513	H61001	20 x 2

- Made with special hard Mn steel, better Toughness
- knife hard higher than 52HRC
- Imported palisander handle, durable for impact
- pls keep the knife neatly after use
- pls don't store in salt suitation to prevent corrosion resistance
- For long time using, pls painting corrosive oil to portect
- NO VDE function
- pls don't knocking, otherwise the handle will break

Bi-Material Hole Electronic Snip



EBS No.	Item No.	L(MM)	pcs-case
1502552	H61911	138MM	12

- Made with high quality steel, HRC 52-56
- Nylon handle, comfortable use
- Used for cutting wire
- Cutting edge could clamp tools, the tota length is 138mm, and the cuttig length is 42mm

Electricians scissors



EBS No.	Item No.	L(MM)	pcs-case
1600101	H61901	138MM	12

- Made with high quality steel, HRC 52-56
- Nylon handle, comfortable use
- Used for cutting wire
- Cutting edge could clamp tools, the tota length is 138mm, and the cuttig length is 42mm

Detecting Screwdriver



EBS No.	Item No.	L(MM)	pcs-case
1501869	H07800	145MM	24 x 12
1501870	H07801	190MM	24 x 12

- Measurement: ≤500VAC
- High quality CR-V knife rod
- CE standard, security for use
- pls do not use as normal screwdriver

Digital Display Detecting Screwdriver



EBS No.	Item No.	pcs-case
1501872	H07804	12 x 12

- No need battery driver, economy and convenient
- Beauty apperance with Full function
- LED display, clearly digital indication
- Used to test 12,36,55,110,220V AC
- pls do not use as normal screwdriver

6Pc Mini Screwdriver Set -Slot & Phillips



EBS No.	Item No.	SIZE(MM)	pcs-case
1501580	H02511	PH00,PH0,PH1,16MM,2MM,24MM	12 x 8

- All the bit torque meets DIN 5286 Standard
- Six mini bit used for most kinds of Slot and phillips trough
- All the bits are made of CRV-Mo, with special hot forging, and the hardness is higher than HRC 52
- Lock the bit security with accurate designed clamp
- Made with aviation aluminum, soft but hard
- Screwdriver with pen shelf, which made with manganese steel, full polish and convenient for use
- Fashion designed apperance, better for home use

6Pc Mini Screwdriver Set -Star & Phillips



EBS No.	Item No.	SIZE(MM)	pcs-case
1501581	H02512	T5,T6,T7,T8,PH00,PH0	12 x 8

- All the bit torque meets DIN 5286 Standard
- Six mini bit used for most kinds of Slot and phillips trough
- All the bits are made of CRV-Mo, with special hot forging, and the hardness is higher than HRC 52
- Lock the bit security with accurate designed clamp
- Made with aviation aluminum, soft but hard
- Screwdriver with pen shelf, which made with manganese steel, full polish and convenient for use
- Fashion designed apperance, better for home use

15Pc Precision Screwdriver Set



EBS No.	Item No.	pcs-case
1503590	H02504	12 x 8

- 15Pc Precision Screwdriver Set
- Slot: 1.0x40, 2.0x50, 3.0x50, 3.5x50
- Phillips: PH0x50, PH00x50, PH000x40
- Hex: 1.5x50, 2.0x50, 2.5x50, 3.0x50
- Star: T6x50, T8x50, T10x50, T15x50

PRECISION SLOTTED SCREWDRIVER



EBS No.	Item No.	SIZE(MM)	pcs-case
1502105	H34100	1.0X40MM	12 x 15
1500714	H34105	2.0X40MM	12 x 15
1500715	H34107	3.0X40MM	12 x 15
1500716	H34109	2.0X60MM	12 x 8
1500717	H34112	3.0X100MM	12 x 8
1500718	H34113	4.0X100MM	12 x 8
1500719	H34114	4.0X150MM	12 x 18
1501228	H34115	2.5X40MM	12 x 18
1501229	H34116	2.5X60MM	12 x 18
1501230	H34117	3.0X60MM	12 x 18
1501231	H34118	4.0X60MM	12 x 18

- Used for repairing TVs, Watches, Computers, Glasses, Communication equipments etc...
- CR-Mo handle bar, hot forging, better hardness
- Rotary turn cap design

PRECISION HEX SCREWDRIVER



EBS No.	Item No.	SIZE(MM)	pcs-case
1500737	H34401	0.9x40mm	12 x 15
1501235	H34402	1.3x40mm	12 x 18
1500738	H34403	1.5x40mm	12 x 15
1500739	H34404	2.0x40mm	12 x 15
1500740	H34405	2.5x40mm	12 x 15
1500742	H34407	2.5x60mm	12 x 15
1500741	H34406	3.0x40mm	12 x 15
1500743	H34408	3.0x60mm	12 x 15

- Used for repairing TVs, Watches, Computers, Glasses, Communication equipments etc...
- CR-Mo handle bar, hot forging, better hardness
- Rotary turn cap design

PRECISION PHILLIPS SCREWDRIVER



EBS No.	Item No.	SIZE(MM)	pcs-case
1500720	H34200	PH00x40mm	12 x 15
1500724	H34204	PH00x60mm	12 x 15
1500721	H34201	PH00x40mm	12 x 15
1501232	H34210	PH00x60mm	12 x 15
1500722	H34202	PH0x40mm	12 x 8
1501233	H34211	PH0x60mm	12 x 8
1500725	H34207	PH0x100mm	12 x 8
1500723	H34203	PH1x40mm	12 x 8
1500726	H34208	PH1x100mm	12 x 18
1500727	H34209	PH1x150mm	12 x 18

- Used for repairing TVs, Watches, Computers, Glasses, Communication equipments etc...
- CR-Mo handle bar, hot forging, better hardness
- Rotary turn cap design

PRECISION TORX SCREWDRIVER



EBS No.	Item No.	SIZE(MM)	pcs-case
1500728	H34300	T5x40mm	12 x 15
1500729	H34301	T6x40mm	12 x 15
1500730	H34302	T7x40mm	12 x 15
1500731	H34303	T8x40mm	12 x 15
1500732	H34304	T9x40mm	12 x 15
1500733	H34305	T10x40mm	12 x 15
1500734	H34306	T15x40mm	12 x 15
1501234	H34311	T10x60mm	12 x 15
1500735	H34309	T15x60mm	12 x 15
1500736	H34310	T20x60mm	12 x 15
1501414	H34001	T5x60mm	12 x 18

- Used for repairing TVs, Watches, Computers, Glasses, Communication equipments etc...
- CR-Mo handle bar, hot forging, better hardness
- Rotary turn cap design

Precision Screwdriver-Hex



EBS No.	Item No.	SIZE(MM)	pcs-case
1501236	H34601	2.5x60mm	12 x 15

- Used for repairing TVs, Watches, Computers, Glasses, Communication equipments etc...
- CR-Mo handle bar, hot forging, better hardness
- Rotary turn cap design

H02513 1501582

6Pc Precision Screwdriver Set-Slotted (6Set*4Box)



1.0X40,1.4X50,2.0X50,2.4X50,3.0X50,3.5X50

- Screwdriver body is made with imported SVCM+, and reinforce the durability with heat treatment.
- Mate finish screwdriver body and blackening & phosphating treatment screwdriver head can provides the accuracy measurement.
- Ergonomic Triangle handle is made with PP+TPR material, make user feel light and comfortable.

H02515 1501584

6Pc Precision Screwdriver Set-Star (6Set*4Box)



T6X50,T7X50,T8X50,T9X50,T10X50,T15X50

- Screwdriver body is made with imported SVCM+, and reinforce the durability with heat treatment.
- Mate finish screwdriver body and blackening & phosphating treatment screwdriver head can provides the accuracy measurement.
- Ergonomic Triangle handle is made with PP+TPR material, make user feel light and comfortable.

H02517 1501586

15Pc Precision Screwdriver Set (6Set*2Box)



Slotted: 1.0X40,2.0X50,3.0X50,3.5X50
Phillips: PH0X50,PH00X50,PH000X40
Hex: 1.5X50,2.0X50,2.5X50,3.0X50
Star: T6X50,T8X50,T10X50,T15X50

- Screwdriver body is made with imported SVCM+, and reinforce the durability with heat treatment.
- Mate finish screwdriver body and blackening & phosphating treatment screwdriver head can provides the accuracy measurement.
- Ergonomic Triangle handle is made with PP+TPR material, make user feel light and comfortable.

H02519 1501588

9Pc Precision Screwdriver Set-Slot&Phillips (6Set*2Box)



Slotted: 1.0X40,2.0X50,2.4X75,3.0X75,4X100
Phillips: PH0X75,PH1X100,PH00X75,PH000X40

- Screwdriver body is made with imported SVCM+, and reinforce the durability with heat treatment.
- Mate finish screwdriver body and blackening & phosphating treatment screwdriver head can provides the accuracy measurement.
- Ergonomic Triangle handle is made with PP+TPR material, make user feel light and comfortable.

Precision Screwdriver-Slotted



EBS NO.	Item NO.	SIZE(mm)	pcsxcase
1502106	H34150	1.0x40	20 x 4
1502107	H34151	1.2x40	20 x 4
1502108	H34152	1.4x50	20 x 4
1502109	H34153	1.6x50	20 x 4
1502110	H34154	1.8x50	20 x 4
1502111	H34155	2.0x50	20 x 4
1502112	H34156	2.4x50	20 x 4
1502113	H34157	3.0x50	20 x 4
1502114	H34158	3.5x50	20 x 4
1502115	H34159	2.0x75	20 x 4
1502116	H34160	2.4x75	20 x 4
1502117	H34161	3.0x75	20 x 4
1502118	H34162	3.0x100	20 x 4
1502119	H34163	4.0x100	20 x 4
1502120	H34164	4.0x150	16 x 8

Especially for maintain the TVs, Watches, glasses, phones, cameros, communication equipments, precision equipments and so on.
Mate finish screwdriver body and blackening & phosphating treatment screwdriver head can provides the accuracy measurement. *Ergonomic Triangle handle is made with PP+TPR , make user feel light and comfortable.
Special designed rotating cap for quick switch.

Precision Screwdriver-Star



EBS NO.	Item NO.	SIZE(mm)	pcsxcase
1502131	H34350	T5x50	20 x 4
1502132	H34351	T6x50	20 x 4
1502133	H34352	T7x50	20 x 4
1502134	H34353	T8x50	20 x 4
1502135	H34354	T9x50	20 x 4
1502136	H34355	T10x50	20 x 4
1502137	H34356	T15x50	20 x 4
1502138	H34357	T9x60	20 x 4
1502139	H34358	T10x60	20 x 4
1502140	H34359	T15x60	20 x 4
1502141	H34360	T20x60	20 x 4
1502142	H34362	T3x40	20 x 4
1502143	H34363	T4x40	20 x 4

Especially for maintain the TVs, Watches, glasses, phones, cameros, communication equipments, precision equipments and so on.
Mate finish screwdriver body and blackening & phosphating treatment screwdriver head can provides the accuracy measurement. *Ergonomic Triangle handle is made with PP+TPR , make user feel light and comfortable.
Special designed rotating cap for quick switch.

H02514 1501583

6Pc Precision Screwdriver Set-Slotted&Phillips (6Set*4Box)



Slotted: 1.4X50,2.0X50,2.4X50,3.0X50
Phillips: PH0X50,PH00X50,1.0X40,1.4X50,2.0X50,2.4X50,3.0X50,3.5X50

- Screwdriver body is made with imported SVCM+, and reinforce the durability with heat treatment.
- Mate finish screwdriver body and blackening & phosphating treatment screwdriver head can provides the accuracy measurement.
- Ergonomic Triangle handle is made with PP+TPR material, make user feel light and comfortable.

H02516 1501585

7Pc Precision Screwdriver Set-Slotted&Phillips (6Set*4Box)



Slotted: 1.4X50,2.0X50,2.4X50,3.0X50
Phillips: PH0X50,PH00X50,PH000X40

- Screwdriver body is made with imported SVCM+, and reinforce the durability with heat treatment.
- Mate finish screwdriver body and blackening & phosphating treatment screwdriver head can provides the accuracy measurement.
- Ergonomic Triangle handle is made with PP+TPR material, make user feel light and comfortable.

H02518 1501587

7Pc Precision Screwdriver Set-Star (6Set*4Box)



T5X50,T6X50,T7X50,
T8X50,T9X50,T10X50,T15X50

- Screwdriver body is made with imported SVCM+, and reinforce the durability with heat treatment.
- Mate finish screwdriver body and blackening & phosphating treatment screwdriver head can provides the accuracy measurement.
- Ergonomic Triangle handle is made with PP+TPR material, make user feel light and comfortable.

Ball End Precision Screwdriver-Hex



EBS NO.	Item NO.	SIZE(mm)	pcsxcase
1502153	H34550	1.3x50	20 x 4
1502154	H34551	1.5x50	20 x 4
1502155	H34552	2.0x50	20 x 4
1502156	H34553	2.5x75	20 x 4
1502157	H34554	3.0x75	20 x 4

Especially for maintain the TVs, Watches, glasses, phones, cameros, communication equipments, precision equipments and so on.
Mate finish screwdriver body and blackening & phosphating treatment screwdriver head can provides the accuracy measurement. *Ergonomic Triangle handle is made with PP+TPR , make user feel light and comfortable.
Special designed rotating cap for quick switch.

Precision Screwdriver-Phillips



EBS NO.	Item NO.	SIZE(mm)	pcsxcase
1502121	H34250	PH000x40	20 x 4
1502122	H34251	PH00x50	20 x 4
1502123	H34252	PH0x50	20 x 4
1502124	H34253	PH1x50	20 x 4
1502125	H34254	PH000x75	20 x 4
1502126	H34255	PH00x75	20 x 4
1502127	H34256	PH0x75	20 x 4
1502128	H34257	PH0x100	20 x 4
1502129	H34258	PH1x100	20 x 4
1502130	H34259	PH1x150	16 x 8

Especially for maintain the TVs, Watches, glasses, phones, cameros, communication equipments, precision equipments and so on.
Mate finish screwdriver body and blackening & phosphating treatment screwdriver head can provides the accuracy measurement. *Ergonomic Triangle handle is made with PP+TPR , make user feel light and comfortable.
Special designed rotating cap for quick switch.

Precision Screwdriver-Hex



EBS NO.	Item NO.	SIZE(mm)	pcsxcase
1502144	H34450	0.67x40	20 x 4
1502145	H34451	0.9x40	20 x 4
1502146	H34452	1.3x50	20 x 4
1502147	H34453	1.5x50	20 x 4
1502148	H34454	2.0x50	20 x 4
1502149	H34455	2.5x50	20 x 4
1502150	H34456	3.0x50	20 x 4
1502151	H34457	2.5x75	20 x 4
1502152	H34458	3.0x75	20 x 4

Especially for maintain the TVs, Watches, glasses, phones, cameros, communication equipments, precision equipments and so on.
Mate finish screwdriver body and blackening & phosphating treatment screwdriver head can provides the accuracy measurement. *Ergonomic Triangle handle is made with PP+TPR , make user feel light and comfortable.
Special designed rotating cap for quick switch.

Anti-Static Lead Free Digital Display Soldering Station



EBS No.	Item No.	pcs/case
1900085	H07301	1 x 6

- Increase or decrease temperature quickly
- ESD Design, for resistance purpose
- Automatic sleeping design, extension lifetime
- Accurate wire, keep the temperature ± 2
- quick response and increase temperature

10Pc Lead Free Soldering Tip Set-Conical B Type



EBS No.	Item No.	SIZE	pcs/case
1501505	H02021	Conical B Type	8 x 6

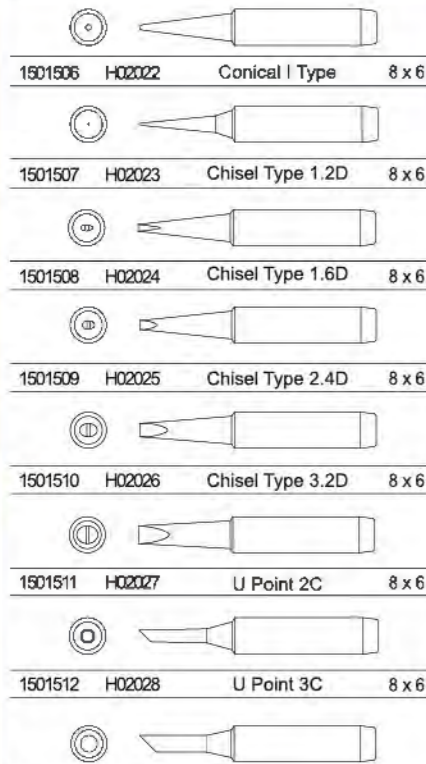

- For H07301 use

Professional Lead Free Intelgent Soldering Station



EBS No.	Item No.	pcs/case
1900086	H07302	1 x 6

- Made with high temperature core, long lifetime
- Increase temperature quickly
- Digital adjust temperature
- Quick change temoeraure, flexible use"

5Pc Lead Free Soldering Tip Set-Conical B Type



EBS No.	Item No.	SIZE	pcs/case
1501516	H02041	Conical B Type	12 x 8

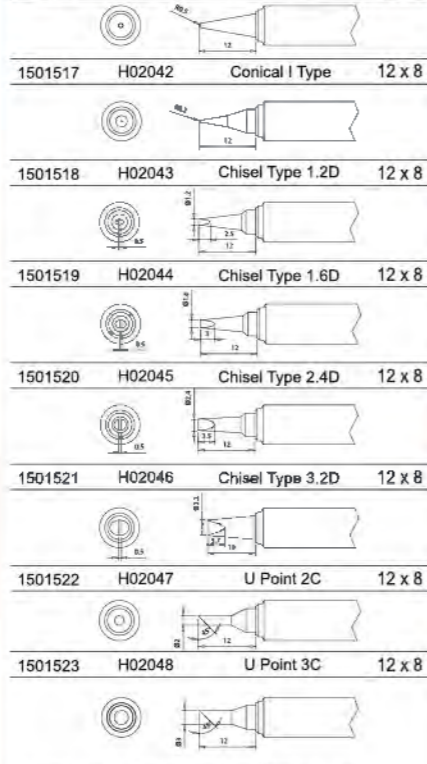

- Special Casing Design, small resistance for touch
- Combine H07302 use"

Professional Internal Soldering Iron-25W Ceramic



EBS No.	Item No.	SIZE(W)	pcs/case
1501823	H07150	25W	6 x 4

- Made with High quality ceramics core central, quick increase temperature
- 420-450 temperature, long life, protect the enviroment
- Combine with 900M solder tip
- Non-lead long lifetime solder tip, especially for welded technical, could use in production line

Professional Internal Soldering Iron-40W Ceramic



EBS No.	Item No.	SIZE(W)	pcs/case
1501824	H07151	40W	6 x 4

- Especial for industrial and mining area
- Made with High quality ceramics core central, quick increase temerature
- 420-450 temperature, long life, protect the environment
- Non-lead long lifetime solder tip, especially for welded technical, could use in production line

Professional Internal Soldering Iron-60W Ceramic



EBS No.	Item No.	SIZE(W)	pcs/case
1501825	H07152	60W	6 x 4

- Especial for industrial and mining area
- Made with High quality ceramics core central, quick increase temperature
- 420-450 temperature, long life, protect the enviroment
- Non-lead long lifetime solder tip, especially for welded technical, could use in production line

Rapid Heating Dual Power Soldering Iron-20/130W



EBS No.	Item No.	SIZE(W)	pcs/case
1501826	H07153	20W/130W	18 x 2

- Traditional soldering, one wattage, but H07153 has two wattage, only need to press the butun, the wattage will increase from 20W to 130W
- With ceramics heat elements, adiabatic handle prenent thorny.Thick design,

Long Life External Heating Soldering Tip



EBS No.	Item No.	SIZE(W)	pcs/case
1600068	H07100	30W	18 x 2
1501803	H07110	40W	18 x 2
1501812	H07120	50W	1 x 1
1501816	H07130	60W	1 x 1

- Nature Made Natural mica double nichrome wire fire, durable for use
- High working efficiency
- High security for using
- Comfortable use
- pls use Gem-Year External Heating Soldering Tip and Natural Mica together

Long Life Heating Soldering

Simple Changeable Device

Portable Soldering Shelf

Multi Selection Better Quality Solidering

Lead Free Internal Soldering Tip



EBS No.	Item No.	SIZE(W)	pcs/case
1501827	H07154	0.2I	250 x 4
1501828	H07155	0.5B	250 x 4
1501829	H07156	1.2D	250 x 4
1501830	H07157	1.6D	250 x 4
1501831	H07158	2.4D	250 x 4
1501832	H07159	3.2D	250 x 4
1501833	H07160	2C	250 x 4
1501834	H07161	3C	250 x 4
1501835	H07162	4C	250 x 4
1501836	H07163	5K	250 x 4
1501837	H07164	B	250 x 4
1501838	H07165	6C	130 x 4
1501839	H07166	T-B	130 x 4

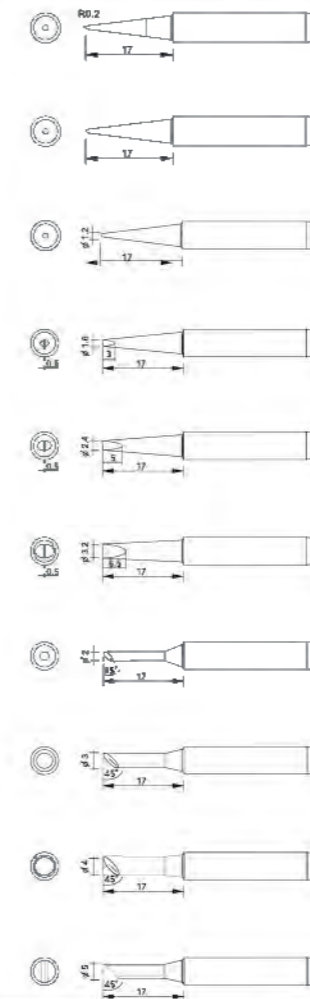

- Made with High quality Natural Mica
- Special surface finish, durable for use and prevent corrosion
- 40000 welding spot for normal use
- Easy for use with tin finish head

Long Life External Heating Soldering Tip



EBS No.	Item No.	SIZE(W)	pcs/case
1501799	H07101	30W	250 x 4
1501800	H07102	40W	250 x 4
1501801	H07104	50W	250 x 4
1501804	H07111	30W	250 x 4
1501805	H07112	40W	250 x 4
1501807	H07114	50W	250 x 4
1501813	H07121	30W	250 x 4
1501814	H07122	40W	250 x 4
1501815	H07124	50W	250 x 4
1501817	H07131	30W	250 x 4
1501818	H07132	40W	250 x 4

- Made of high quality steel
- Tin finish
- For Gem-Year External Heating Soldering Tip use



Item No.	SIZE(W)	(A)	(B)	(C)
1501801	50W 250x4	7.0x8	1.8x4	11.5
1501802	40W 250x4	7.0x8	1.8x4	11.5
1501803	30W 250x4	7.0x8	1.8x4	11.5
1501804	50W 250x4	7.0x8	1.8x4	11.5
1501805	40W 250x4	7.0x8	1.8x4	11.5
1501806	30W 250x4	7.0x8	1.8x4	11.5

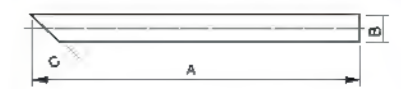

Item No.	SIZE(W)	(A)	(B)	(C)
1501807	50W 250x4	7.0x8	1.8x4	11.5
1501808	40W 250x4	7.0x8	1.8x4	11.5
1501809	30W 250x4	7.0x8	1.8x4	11.5



Item No.	SIZE(W)	(A)	(B)	(C)
1501810	50W 250x4	7.0x8	1.8x4	11.5
1501811	40W 250x4	7.0x8	1.8x4	11.5
1501812	30W 250x4	7.0x8	1.8x4	11.5

External Soldering Heating Element-Natural Mica



EBS No.	Item No.	SIZE(W)	pcs-case
1501819	H07141	30W	120 x 4
1501820	H07142	40W	120 x 4
1501821	H07143	50W	120 x 4
1501822	H07144	60W	120 x 4

- For Gem-Year Long Life External Heating Soldering Ti use
- Long life Heating soldering
- India made Natural mica double nichrome wire fire
- Easy for replacement

Solder Bar



EBS No.	Item No.	SIZE	pcs-case
1900084	H07113	1.0MM/17g	120x6

- GB and ASTM Resquirement
- Highly purified lead-tin alloy, 63% Tin content, 2% flux content, suitable for the limit temperature rigid printed circuit board, and other requirements for relatively narrow spcae
- Solder residue during welding, small light corrosion resistance
- Improve working efficiency and snsure security"

Solder Coil

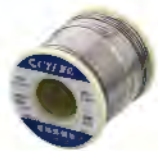

EBS No.	Item No.	SIZE	pcs-case
1501808	H07115	0.5MM/250g	10 x 4
1501809	H07116	0.8MM/250g	10 x 4
1501810	H07117	1.0MM/250g	10 x 4
1501811	H07118	1.0MM/500g	6 x 4

6Pc Welding Assistant Tool



EBS No.	Item No.	pcs-case
1501796	H07008	12 x 18

- Include terminal, looper, hook, fork,knife, scraper, awl and brush

PLCC Puller



EBS No.	Item No.	pcs-case
1501789	H07000	12 x 30

- Separate the PLCC security and convenient
- Single hand operation, easy for use
- PLCC Function:20 feet-80 feet

IC Clip



EBS No.	Item No.	SIZE	pcs-case
1501790	H07001	IC Clip	12 x 40

- Separate the PLCC security and convenient from the circuit board
- PLCC Function:20 feet-80 feet

Tweezer-Sharp Point



EBS No.	Item No.	L(MM)	pcs-case
1501845	H07400	125	12 x 12

Long Tweezer-Extra Sharp Point



EBS No.	Item No.	L(MM)	pcs-case
1501846	H07401	135	12 x 12

Short Tweezer-Extra Sharp Point



EBS No.	Item No.	L(MM)	pcs-case
1501847	H07402	115	12 x 12

Tweezer-Spade Point



EBS No.	Item No.	L(MM)	pcs-case
1501848	H07403	120	12 x 12

Tweezer-Little Sharp Point



EBS No.	Item No.	L(MM)	pcs-case
1501849	H07404	115	12 x 12

Tweezer-Bent Point



EBS No.	Item No.	L(MM)	pcs-case
1501850	H07405	118	12 x 12

- Made of High quality antimagnetic stainless
- Fine Sophisticated Head, for different size element use
- Suitable hardness head, ensure working condition
- Widely used for Hospital, beauty gardening, technical repairing and agriculture assembling and so on

Anti-Static tweezers Sharp Point



EBS No.	Item No.	L(MM)	pcs-case
1501854	H07421	130	10 x 12

Anti-Static tweezers Spade Point



EBS No.	Item No.	L(MM)	pcs case
1501855	H07422	130	10 x 12

Anti-Static tweezers Bent Point



EBS No.	Item No.	L(MM)	pcs-case
1501856	H07423	130	10 x 12

- Made of High quality antimagnetic stainless
- Fine Sophisticated Head, for different size element use
- Used for anti-static electronic parts and components use

Anti-Slip tweezers Sharp Point



EBS No.	Item No.	L(MM)	pcs-case
1501851	H07411	175	12 x 12

Anti-Slip tweezers Bent Point



EBS No.	Item No.	L(MM)	pcs-case
1501852	H07412	175	12 x 12

Anti-Slip tweezers Sharp Point



EBS No.	Item No.	L(MM)	pcs-case
1501853	H07413	170	12 x 12

- Made of High quality antimagnetic stainless
- Fine Sophisticated Head, for different size element use
- Suitable hardness head, ensure working condition
- Widely used for Hospital, beauty gardening, technical repairing and agriculture assembling and so on

Walnut Brush-Hickory Handle



EBS No.	Item No.	pcs-case
1501797	H07009	6 x 6

- Brush handle Resistance<10°, Brush hair<10°

Anti-Static Brush- Small Straight Handle



EBS No.	Item No.	pcs-case
1501792	H07004	12 x 8

- Brush handle Resistance<10 , Brush hair<10

Anti-Static Brush- Small U Handle



EBS No.	Item No.	pcs-case
1501792	H07005	3 x 6

- Brush handle and head Made of conducting PP material, high elasticity, no dust during the cleaning process
- Used for normal detergent use, such as gasonline, olein, acetone and Freon. Not influence the surface and perference

Anti-Static Alcohol Bottle



EBS No.	Item No.	pcs-case
1501791	H07003	10 x 8

- Widely used in production and lab test
- Stainless prevent Corrosion
- Perfect combine for the stainless pump and bottle
- anti-static ensure the security
- Cleaning each pump before delivery
- Prevent the dust went to the bottle
- Special pump head prevent volatilization

18LED Rechargeable Water Proof Flashlight



EBS No.	Item No.
2800123	H07634
2800124	H07635

- Charge Time: 5H
- Discharge Time: 1.5H-2H
- Better Resistant water and oil, Could use in bad environment
- Could Buckle in Belt, for outdoor bringing
- Environmental protection charge lithium Battery, extra long battery life
- Red and Green charge lamp, for simple display
- Rubber painting, comfortable using

Handheld Rechargeable Latern



EBS No.	Item No.
2800128	H07643

- 17LED Light, 1.5W Hard Light
- 12LED Outer LED1, Save Power, Durable for use
- Inner 3.7V/2200mAhG High quality charge lithium Battery
- Could Charge 220V Power and Auto Charge use
- Could Discharge Hard Light 5H, LED 8H, Charge time 4.5H
- Three Gears, Hard Light, LED and Interval flashing
- Range blanking: More than 1000Metre

Rechargeable Flashlight



EBS No.	Item No.	pcs-case
2800116	H07606	6 x 6

- Suitable for patrolling and camping lighting
- Made with US CREE XP-E R3 super power LED lighting
- High performance lithium-ion rechargeable battery, with 6 grade model design
- Durable flashlight body with integrated design
- Waterproof and Dustproof design, ensure for security
- Either one 18650 lithium-ion battery or two CR123A disposable lithium-ion battery could work
- Waterproof silica ring in fluorescence head, for easy found in black night
- IP 67 waterproof standard design
- Lighting distance according to ANSI/NEMA FL-1 standard
- Caution: Please don't knock the flashlight and keep stable

Aluminum Flashlight-One 7# Battery



EBS No.	Item No.	SIZE	pcs-case
2800110	H07600	1LED	6 x 8
2800111	H07601	5LED	6 x 8
2800112	H07602	24LED	6 x 6
2800113	H07603	Cree LED 3W	6 x 6
2800114	H07604	Cree LED 3W	6 x 6

- Made with American Cree 3W LED, 90LM lighting
- Individual 12000MCD lighting, 100000H lifetime
- Durable for Use
- Waterproof and Dustproof design, ensure for security

30 LED Handled Flashlight



EBS No.	Item No.	Size(MM)	N.W(KG)	Capacity
2800121	H07632	420	0.6	2000

- Charge 3.5hour, could work 7 hours
- The data is based on lab test only, the actual time will be a little difference

Anti-Static Strap



EBS No.	Item No.	pcs-case
2600046	H07002	10 x 8



- Adjustable length, for different users
- Nets organize, not distortion
- Release static during 10.1 minute
- Security use for clean room
- 3 meter Copper Core PU wire
- 1 megohm resistance, ensure security for users

26LED Foldable Rechargeable Flashlight



EBS No.	Item No.	SIZE
2800126	H07641	220
2800127	H07642	220

- Charge Time: 5H
- Discharge Time: 1.5H-2H
- East Attache to Metal Products and hanging, Convenient for Use
- Normal Condition 21LED, Save Condition 51LED
- Seal Design prevent dust to access
- Small, easy to take
- Environmental protection charge lithium Battery, extra long battery life
- Rubber painting process, Comfortable take

Digital Multimeter



EBS No.	Item No.
2200053	H07700

- GMM Used in electrical measurements
- Many Special Functions, Main Function is detect Voltage, Resistance and Current
- As a modern electrical measurements, Main used in physical, electric and ekectron Area
- GB Standard Certificate
- UL and CE Safety Standard
- China Appearance patent: CN200730331538.1

Super Power Rechargeable Flashlight



EBS No.	Item No.	pcs-case
2800115	H07605	4 x 6

- Suitable for patrolling and camping lighting
- Made with US CREE XP-E R3 super power LED lighting
- High performance Ni-Mh rechargeable battery, could work 4 hours once fully charged
- Durable flashlight body with integrated design
- Waterproof and Dustproof design, ensure for security
- Either two No. 5 battery or two Ni-Mh disposable lithium-ion battery could work
- Waterproof silica ring in fluorescence head, for easy found in black night
- IP 67 waterproof standard design
- Lighting distance according to ANSI/NEMA FL-1 standard
- Caution: Please don't knock the flashlight and keep stable

Pen Flashlight



EBS No.	Item No.	pcs-case
2800117	H07607	12 x 3

- Special pen design for convenient purpose
- Made with US CREE R2 super power LED lighting
- Soft light with aluminum orange reflect ring With 2 standard No.7 battery
- Waterproof and dustproof design, ensure security
- Super light LED may come hot due to the high heat energy
- Caution: Please don't knock the flashlight and keep stable

60 LED Handled Flashlight



EBS No.	Item No.	Size(MM)	N.W(KG)	Capacity
2800122	H07633	500	0.51	2000

- Charge 3.5hour, could work 4.5 hours
- The data is based on lab test only, the actual time will be a little difference

Plastic Accessories Bag



EBS No.	Item No.	pcs-case
2404325	H07007	12 x 6

PVC electric Insulated belt



EBS No.	Item No.	SIZE	pcs-case
1501794	H07006	19x9.1x0.16	10 x 10

H07621	2800118	H07622	2800119
Functional Head Flashlight	(6pcsx4case)	Functional Head Flashlight	(6pcsx4case)



- Functional head flashlight
- Suitable for patrolling and camping lighting
- Super LED lighting could reach 35lm, 1000000 hours lifetime
- Waterproof and dustproof design, ensure security
- With 3 AAA high quality battery, the battery could use 5 years



- Suitable for patrolling and camping lighting
- Made with US CREE-1W Super LED lighting could reach 50lm, 1000000 hours lifetime,
- more than 50M lighting distance
- Waterproof and dustproof design, ensure security
- With 3 AAA high quality battery, the battery could use 5 years

Heat Gun



EBS No.	Item No.	pcs/case
1600076	H07521	1 x 8

- Electric Power:220V 50Hz
- Rate Power:1600 Watt
- Double temperature:350-500 C
- Double Speed:350/500 volume/Minute
- Weight with electric wire:680g
- Double Protection, more security
- Exceed temperature protection ensure the normal work
- 100% inspection before deliver
- improted core component
- Special shelf design, easy use and convenient operation
- Europe Design, Europe Technical, Assembled in Shanghai
- Individual application needs for special wind mouth
- Guarantee for 3 mouths except the heater

Variable Heat Gun



EBS No.	Item No.	pcs/case
1600077	H07522	1 x 8

- Electric Power:220V 50Hz
- Rate Power:1800 Watt
- Double temperature:100-550 C
- Double Speed:250/550 volume/Minute
- Weight with electric wire:720g
- Double Protection, more security
- Exceed temperature protection ensure the normal work
- 100% inspection before deliver
- improted core component
- Special shelf design, easy use and convenient operation
- Europe Design, Europe Technical, Assembled in Shanghai
- Individual application needs for special wind mouth
- Guarantee for 3 mouths except the heater

Digital Display Heat Gun



EBS No.	Item No.	pcs/case
1600078	H07523	1 x 8

- Electric Power:220V 50Hz
- Rate Power:2000 Watt
- Double temperature:80-650 C
- Double Speed:200/550 volume/Minute
- Weight with electric wire:780g
- Double Protection, more security
- Exceed temperature protection ensure the normal work
- 100% inspection before deliver
- improted core component
- Special shelf design, easy use and convenient operation
- Europe Design, Europe Technical, Assembled in Shanghai
- Individual application needs for special wind mouth
- Guarantee for 3 mouths except the heater

	H07521	H07522	H07523
Air Spreader			
Nozzle-Glass Proof		•	•
Air Spreader	•	•	•
Nozzle-Spade Point		•	•
Air Spreader	•	•	•
Nozzle-Speed Reduce		•	•
Air Spreader		•	•
Nozzle-Reflection		•	•
Air Spreader	•	•	•
Nozzle-Welding		•	•
Air Spreader		•	•
Nozzle-Stitch Welding		•	•
Air Spreader		•	•
Nozzle-Soldering		•	•

Roller



EBS No.	Item No.	pcs/case
1501864	H07508	6 x 4

- Used For Furniture trim, repair and weld use

Air Spreader Nozzle-Soldering



EBS No.	Item No.	pcs/case
1600075	H07507	6 x 6

- Used For hot mould pipe use

EBS No.	Item No.	pcs/case
1600069	H07501	6 x 6

- Used For protect the glass when Peel the paint in the Fiberglass

Air Spreader Nozzle-Spade Point



EBS No.	Item No.	pcs/case
1600070	H07502	6 x 6

- Used For Peel the paint

Air Spreader Nozzle-Speed Reduce



EBS No.	Item No.	pcs/case
1600071	H07503	6 x 6

- Used For Peel the tag

Air Spreader Nozzle-Reflection



EBS No.	Item No.	pcs/case
1600072	H07504	6 x 6

- Used For Socket welded and sharpen process

Air Spreader Nozzle-Welding



EBS No.	Item No.	pcs/case
1600073	H07505	6 x 6

- Used For Pendulum welded

Air Spreader Nozzle-Stitch Welding



EBS No.	Item No.	pcs/case
1600074	H07506	6 x 6

- Used For Repair and Weld

H02031 1600063
3PC Heat Gun Set (8set/cn)



- 1-Heat Gun
- 1-Air Spreader Nozzle-Reflection
- 1-Air Spreader Nozzle-Spade Point
- Electric Power:220V 50Hz
- Rate Power:1600 Watt
- Double temperature:350-500 C
- Double Speed:350/500 volume/Minute
- Weight with electric wire:680g
- Double Protection, more security
- Exceed temperature protection ensure the normal work
- 100% inspection before deliver
- improted core component
- Special shelf design, easy use and convenient operation
- Europe Design, Europe Technical, Assembled in Shanghai
- Individual application needs for special wind mouth

H02032 1501514
4PC Variable Heat Gun Set (8set/cn)



- 1-Variable Heat Gun Set
- 1-Air Spreader Nozzle-Reflection
- 1-Air Spreader Nozzle-Glass proof
- 1-Air Spreader Nozzle-Speed Reduce
- Electric Power:220V 50Hz
- Rate Power:1600 Watt
- Double temperature:350-500 C
- Double Speed:350/500 volume/Minute
- Weight with electric wire:720g
- Double Protection, more security
- Exceed temperature protection ensure the normal work
- 100% inspection before deliver
- improted core component
- Special shelf design, easy use and convenient operation
- Europe Design, Europe Technical, Assembled in Shanghai
- Individual application needs for special wind mouth

H02033 1501515
6PC Digital Display Heat Gun Set (8set/cn)



- 1-Digital Heat Gun Set
- 1-Air Spreader Nozzle-Stitch Welding
- 1-Air Spreader Nozzle-Soldering
- 1-Air Spreader Nozzle-Welded
- 1-Roller
- Electric Power:220V 50Hz
- Rate Power:1600 Watt
- Double temperature:350-500 C
- Double Speed:350/500 volume/Minute
- Weight with electric wire:720g
- Double Protection, more security
- Exceed temperature protection ensure the normal work
- 100% inspection before deliver
- improted core component
- Special shelf design, easy use and convenient operation
- Special automatic tempering system, ensure temperature
- Europe Design, Europe Technical, Assembled in Shanghai
- Individual application needs for special wind mouth

Solder Sucker-Plastic



EBS No.	Item No.	pcs/case
1501840	H07200	12 x 4

- High suction for quick separate the soldering
- Better PTEE Three suction nozzle, durable for high temperature, slovent resistance

Solder Sucker-Aluminum



EBS No.	Item No.	pcs/case
1501841	H07201	12 x 4

- High suction for quick separate the soldering
- Better PTEE Three suction nozzle, durable for high temperature, slovent resistance

5Pc Solder Sucker Tip Kits



EBS No.	Item No.	pcs/case
1501842	H07202	25 x 4

- High suction for quick separate the soldering
- Better PTEE Three suction nozzle, durable for high temperature, slovent resistance

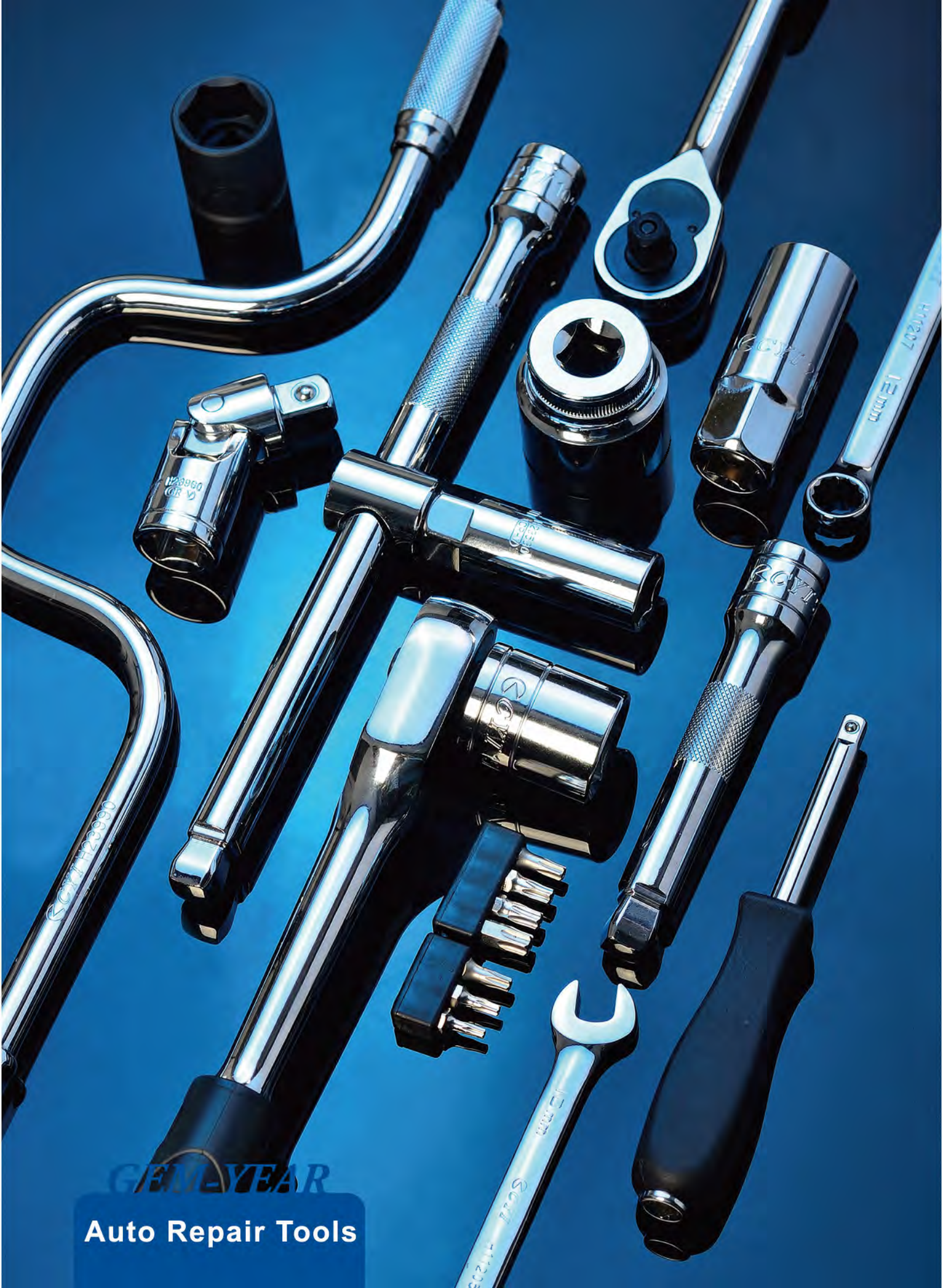

H01010 1500013
78-6.3*12,5MM Combination Set (2set/ctn)



- 11-Metric Combination Wrench-5.5MM , Full Polish (8,10,12,13,14,15,16,17,18,19MM)
- 7-6.3MM Dr Socket Set- Metric (7,8,9,10,11,12,13MM)
- 12-12MM Dr Socket Set- Metric (8,10,12,13,14,15,16,17,18,19,22,24MM)
- 2-Spark plug socket (16 , 21MM)
- 1-6.3MM quick-release Ratechet
- 1-12MM quick-release Ratechet
- 1-6.3MM Flexible Head Handle
- 1-6.3MM Sliding Handle
- 1-6.3MM Flexible Adaptor-6"
- 2-6.3MM Ball End Extension Bar- (2" , 4")
- 1-Universal Joint
- 1-10MM Adaptor Socket-10MM Female (Hole)X12.5MM Male, 3 Way
- 1-12.5MM Universal Joint
- 1-12.5MM Bit Holder
- 18-6.3MM Bit Socket
 Star:(T8,10,15,20,25,30,40)
 Hex:(3,4,5,6MM)
 Phillips:(PH1,PH2)
 Pozidriv:(PZ1,PZ2)
 Slot:(4,5,5,6,5MM)
- 15-8MM Long Screwdriver Bit Set
 Star:(T40,45,50,55)
 Hex:(8,10,12,14MM)
 Phillips:(PH3,PH4)
 Pozidriv:(PZ3,PZ4)
 Slot:(8,10,12MM)

• For Automobile Common Repairing Use.

H01019 1501486
121Pc 6.3,10 & 12.5MM Dr Socket & Wrench Set-Auto Repair (2set/ctn)



- 1-slot Go-Through screwdriver-6*100MM
- 1-phillips Go-Through screwdriver-PH2*100MM
- 1-10MM Two Way Oil Filter Wrench-63-102MM
- 1-T52 T52 cylinder head Bolt Special Socket
- 1set 18-6.3MM 25MM metric bit holder
- 1-6.3MM bit holder socket
- 8-10MM star bit set-six point(T8,T10,T11,T12,T14,T16,T18,T20)
- 4-10MM bit holder socket-6 point (3,4,5,6MM)
- 2-10MM slot bit holder(5,5,6MM)
- 2-10MM phillips bit holder (PH1,PH2)
- 3-10MM star bit holder(T20,T30,T40)
- 4-10MM serious 50MM Dr Bit Set-Security Star (TT45,TT50,TT55,TT60)
- 1-6.3MM Dr ball end extension bar-2"
- 1-6.3MM quick-release ratchet
- 1-6.3MM universal joint
- 1-6.3MM Flexible Head Handle
- 1-10MM extension bar-3"
- 1-10MM extension bar-6"
- 1-10MM quick-leas ratchet
- 1-10MM universal joint
- 1-10MM Dr Adaptor Socket-10MM FemaleX6.3MM Male
- 1-10MM Dr Adaptor Socket-10MM FemaleX12.5MM Male
- 1-12.5MM extension bar-5"
- 1-12.5MM extension bar-10"
- 10-6.3MM metric socket-6 point(4,5,6,7,8,9,10,11,12,13MM)
- 4-6.3MM metric long socket (8,9,10,12MM)"

H01013 1501481
56Pc Auto Pit Shop Tool Set (2set/ctn)



- 11- Combination Wrench-Full Polish (8,10,12,13,14,1,16,17,18,19,22MM)
- 2-10MM spark plug socket
- 15-10MM Socket Wrench-6 Point
- 1-10MM quick release ratchet
- 2-10MM Ball End Extension Bar (3" , 10")
- 1-10MM Universal Joint-1/2" Female(Hole)X 3/8" Male
- 1-12.5MM Adaptor Socket-1/2" Female(Hole)X 3/8" Male, 3 Way
- 1-6.3MM Bit driver
- 1-6.3MM Bit holder
- 15-6.3MM long bit-25MM Star-(T10,T15,T20,T25,T30,T40) Hex-(3,4,5,6MM) Slot(4,5,6,5MM) Phillips(PH1,PH3)
- 1-Go-through screwdriver-Slot (6*100MM)
- 1-Go-through screwdriver-Phillips (PH2*100MM)
- 1-Slip Joint Pelier 8"
- 1-Long Nose Plier 6"



H02006 1501498
Screw Type Clamp Set (8set/ctn)



- Used to remove valve spring
- Bow Construction ensure valve coaxiality
- Joint Size: 16, 19, 23, 25, 30MM
- Screw Thread Length: 70, 110, 10MM

H02010 1501501
12Pc Driving Wheel Assembly Tool Set (12set/ctn)



- Include Alligator, bearing, support rod, non-slip washer, Quad4 Pin, GM3.1 Pin, Quad4 screwdriver push bar, Ford 4.6 Moular screddriver push bar, and other cars push bar, GM 3.1 screwdriver push bar, button head
- Remove almost kinds of China made generator pulley

H02011 1501502
37PC Bolt Type Assembly Tool Set (4set/ctn)



- Include 4 remover conjugate, long silk, short silk, long Plane terminal, short Plane terminal, screws. (5/16-18*4-1/2*3pcs)
- 5/16-24*4v*3pcs
- 3/8-16*4*3pcs
- 8MM 1.25*65*2pcs
- 8MM 1.25*80*3pcs
- 8MM 1.25*40*3pcs
- 10MM 1.25*50*3pcs
- 3/8-16*2*3pcs
- 3/8-24*2*3pcs
- 5/16-18*2*3pcs
- Used to remove the semiaxis balancer
- Used to remove the engine flywheel "

H02009 1501500
Bearing Separator Tool Set 30-75MM (2set/ctn)



- Used to remove kinds of bearings, from 30-75MM

H02004 1501497
8-End Cap Auto Filter Wrench Set (3set/ctn)



- 6-Fliter Wrench set(65,74,76,80,90,93MM)
- 1-10MM Quick-Release Ratchet
- 1-12.5MM Adaptor
- Fliter Combine with 3/8 DR or 1/2DR driver Adaptable Auto:
- 65MM, 14flutes: For TOYOTA, NISSAN, CHANGANALTO, LEXUS, DIANHATSU
- 74MM, 15flutes: For BUICK, GM, SATURN
- 76MM, 14flutes: For MORAR, VE, PORSCHE, MERCEDES, BMW
- 80MM, 15flutes: For HONDA, ACCORD, NISSAN, TOYOTA
- 90MM, 15flutes: For HINDA, ACCORD, MITSUBISHI, MOPAR, ISUZU
- 93MM, 15flutes: For HASTINGS, PUROLATOU, WIX, NISSAN, VW, PORSCHE, RENAULT

H02008 1501499
12-Brake Branch Pump Adjustment Tool Set (8set/ctn)



- Normal Adjustable Pump, for change brake block
- Accurate process, smooth screw

Tie Rod Remover(Small)



EBS No.	Item No.	SIZE(mm)	pcs-case
1501778	H06701	Small	1 x 8

- Used for seperating the ball head, special lengthing 20% washer, for big area use
- CR-V puller, heat treatment for suitable use

Ball Joint Sperator(DIN)



EBS No.	Item No.	pcs-case
1501779	H06702	1 x 12

- Heat treatment process, durable for impact
- Could Use in narrow space, easy to remove the ball joint seperator

Ball Joint Sperator(JIS)



EBS No.	Item No.	pcs-case
1501780	H06703	1 x 12

- Special sperate design, could use to remove most kinds of car and trunk ball end.
- Opening: 30MM-50MM

Ball Joint Sperator



EBS No.	Item No.	SIZE	pcs-case
1501782	H06712	Big	1 x 4

- Used for seperating the ball joint.
- High quality screw ensure the

Timing Belt Wheel Puller



EBS No.	Item No.	pcs-case
1501784	H06714	1 x 8

- Used for removing the bent axle belt plate
- Adjustable strength range, for most kinds of Cars
- Grab length 100MM, width 22MM"

Pitman Arm/Tie Rod End Separator



EBS No.	Item No.	pcs-case
1501783	H06713	1 x 24

- Used for removing the Pitman Arm
- Made of Carbon Steel
- Cold forging, heat treatment
- Attention: Take goggles for use

Separator Tool Fork



EBS No.	Item No.	SIZE(mm)	pcs-case
1501785	H06715	12	2 x 6
1501786	H06716	16	2 x 6

- Used for seperating the ball point from the knuckle
- Insert the tools in suitable palce, then use the hammer to separate it
- Durable for impact

Strut Spring Compressor



EBS No.	Item No.	SIZE(mm)	pcs-case
1501750	H06011	270MM	1 x 9
1501751	H06012	370MM	1 x 6

- Made of High quality carbon steel, ensure strength for use
- 1/2 DR male could use for 1/2DR driver tools and 21MM sockets, wrenches.
- Special strengthen and widen thread design, ensure security

12.5MM double socket



EBS No.	Item No.	SIZE(mm)	pcs-case
1502025	H23955	17x19MM	6 x 16
1502026	H23956	21x23MM	6 x 16

Damper Removing Socket



EBS No.	Item No.	pcs-case
1501774	H06504	10x12

- Used for removing the Front Damper Assembly Socket For VW Santana
- Made of Cr-V

Front Damper Assembly Socket For VW Santana



EBS No.	Item No.	pcs-case
1501772	H06502	6 x 6

- Used for removing the Front Damper Assembly Socket For VW Santana
- Made of Cr-V"

3/4"DR. Spark Plug Socket



EBS No.	Item No.	L(MM)	pcs-case
1500251	H22530	16	6 x 27
1500252	H22531	21	6 x 16
1502005	H22532	18	6 x 16

3Pc L Type Lug Nut Wrench Set



EBS No.	Item No.	pcs-case
1501496	H02003	1 x 6

- Flexible tyre wrench
- 12.5MM double socket 17*19MM
- 12.5MM double socket 21*23MM
- Unextension length is 345MM, and extension length is 535MM"

Rear Damper Assembly Socket For VW Santana



EBS No.	Item No.	pcs-case
1501773	H06503	6 x 15

- Used for removing the Rear Damper Assembly Socket For VW Santana
- Made of Cr-V"

1/2"DR. Spark Plug Socket



EBS No.	Item No.	L(MM)	pcs-case
1500374	H23530	16	4 x 27
1500375	H23531	21	4 x 16

12.5MM L Type Flexible Lug Nut Wrench



EBS No.	Item No.	pcs-case
1502027	H23981	4 x 9

- Unextension length is 345MM, and extension length is 535MM

Tube Tire Valve Inserting Tool-320MM



EBS No.	Item No.	L(MM)	pcs-case
1501329	H06005	320	12 x 6

- Tube Tire Valve Inserting

T Handle Universal Joint Spark Plug Wrench-16MM

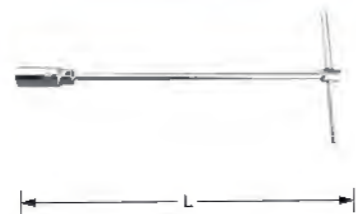

EBS No.	Item No.	L(MM)	pcs-case
1501388	H15551	16	6 x 6
1501389	H15552	21	6 x 6

- 450MM Bar Body
- Magnet Socket
- Made for CR-V, sand finish
- Attached adjustable handle, could use together with ratchet"

12.5mm double head sleeve 17x19MM



EBS No.	Item No.	SIZE	pcs-case
1502025	H23955	17x19MM	6 x 16
1502026	H23956	21x23MM	6 x 16

Dial Kilometer Wrench



EBS No.	Item No.	SIZE(mm)	pcs-case
1501993	H15901	300	1 x 20

- 40CR Head and Body, Durable for using
- Beautiful with Ni plating
- Soft handle for comfortable use

Lug Nut Wrench-4 Way



EBS No.	Item No.	pcs-case
1501434	H15601	1 x 12

- Made of Cr-V
- 17MM, 19, 21MM, Another side is 1/2 Driver

7-Coolant Pipe Joint Assembly Tool Set



EBS No.	Item No.	pcs-case
1501344	H02007	12 x 6

- Used to Remove the airconditioner coil and oil coil
- Size : 1/4(6MM), 5/16(8MM), 3/8(95MM), 1/2(12.7MM), 5/8(16MM), 3/4(19MM), 7/8(22MM)"

Handcuff Oil Filter Wrench-55-75MM



EBS No.	Item No.	SIZE(CC)	pcs-case
1501769	H06323	55~75	12 x 4
1501770	H06324	75~95	12 x 4

Chain Wrench



EBS No.	Item No.	SIZE	Ø	pcs-case
1502546	H61801	12(23point)	Ø65-105	4 x 4
1502547	H61802	15(33point)	Ø60-135	4 x 4

- Made of CR-V Forging

Valve Seal Ring Pliers-10"



EBS No.	Item No.	SIZE(mm)	pcs-case
1501777	H06602	250	3 x 6

- Used for removing Car valve oil seal and valve spring

Two Way Oil Filter Wrench-63-102MM



EBS No.	Item No.	SIZE(MM)	pcs-case
1501767	H06321	63-102	8 x 6

- 1/2 driver, no need to change the driver
- input torque improve 10%

Oil Filter Wrench



EBS No.	Item No.	pcs-case
1501768	H06322	3 x 6

- Used for dismantling the Auto filter for 63.5-116MM
- Suitable for the stubborn, unremoveable Atuo Filter
- Special Two Hold Handle Design, More durable
- Comfortable, Durable Rubber Handle

1/2 Dr Oil Filter Strap Wrench-18"



EBS No.	Item No.	SIZE(mm)	pcs-case
1501771	H06325	18"	6 x 8

- For 1/2Dr. Driving and 13/16Dr. Spinner Handle
- Remove oil Filter, with 120mm diameter"

Oil Filter Cap Wrench-65MM, 14 edges



EBS No.	Item No.	SIZE(mm)	pcs-case
1501238	H06301	65	6 x 6
1501239	H06302	74	6 x 8
1501240	H06303	76	6 x 8
1501241	H06304	80	6 x 8
1501242	H06305	90	12 x 4
1501243	H06306	93	12 x 4

- Special technical design, Chromium plating finish
- Oil Filter work with 3/8Dr. or 1/2Dr. Driving tools
- 65MM, 14flutes, For TOYOTA, NISSAN, CHANGAN, LTO, LEXUS, DIAHATSU
- 74MM, 15flutes, For BUIC, KGM, SATURN
- 76MM, 14flutes, For MOPAR, VW, PORSCHE, MERCEDES, BWM
- 80MM, 15flutes, For HONDA, ACCORD, NISSAN, TOYOKA
- 90MM, 15flutes, For HONDA, ACCORD, MITSUBISHI, MOPAR, ISUZU
- 93MM, 15flutes, For GM FRAM, HASTINGS, PUROLATOR, WIX, NISSAN, VW, PROSCHE, RENAULT

Puller-Three Jaw



EBS No.	Item No.	SIZE	D	L	pcs-case
1502415	H49033	3"	75MM	60MM	1 x 20
1502416	H49034	4"	100MM	70-95MM	1 x 20
1502417	H49036	6"	150MM	120-160MM	1 x 12
1502418	H49038	8"	200MM	175-235MM	1 x 5

- Hot forging micro bar, durable for use
- Heave edge design, ensure hex quality during knocking
- Reasonable claw design, durable for usage

Bearing Separator-30-50MM



EBS No.	Item No.	SIZE(mm)	pcs-case
1501787	H06801	30-50MM	1 x 24
1501788	H06802	50-75MM	1 x 8

- Used to Pull Out the bearing.
- Made of chrome-molybdenum steel

3-Oil and Air Conditioner Routing Stop Tool Set



EBS No.	Item No.	pcs-case
1501343	H02005	12 x 6

- Suitable for almost all Ford, GM and Mazda Auto
- Suitable for Chrysler and Ford air condition electric wire

Piston Ring Compressor-3"



EBS No.	Item No.	SIZE(mm)	pcs-case
1501746	H06001	3"	1 x 24
1501747	H06002	4"	1 x 24

- Spring steel high strength finish, include ratchet system
- Applications: H06001 53-175MM, H06002 60-175MM

Puller-two Jaw

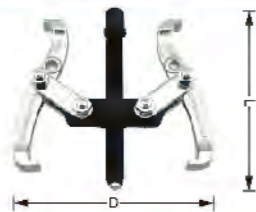

EBS No.	Item No.	SIZE	D	L	pcs-case
1502411	H49023	3"	75MM	60MM	1 x 20
1502412	H49024	4"	100MM	70-95MM	1 x 20
1502413	H49026	6"	150MM	120-160MM	1 x 12
1502414	H49028	8"	200MM	175-235MM	1 x 5

- Hot forging micro bar, durable for use
- Heave edge design, ensure hex quality during knocking
- Reasonable claw design, durable for usage"

Auto Repair Pliers



EBS No.	Item No.	pcs-case
1501776	H06601	4 x 8

- 15MM hold diameter, 280MM length, 30° plier degree

Disc Brake Adjuster



EBS No.	Item No.	pcs-case
1501749	H06004	1 x 12

- Used for presuring the piston when install the brake block
- Special design, convenient use
- Fine screw thread design, accurate for adjust
- Excellent Performance"

8 Stripping Pliers- Seven in One



EBS No.	Item No.	pcs-case
1501775	H06600	4 x 8

- 7 functions in one tools
- Pliers
- VDE Insulated Pliers
- Wire Stripper (0.75-6MM)
- Normal Insulated Pliers 7-8MM
- Car Pliers
- Screw Cutting Plier M2.6-M5

Piston Grip Air Gun-100MM Lever



EBS No.	Item No.	pcs-case
1501380	H06401	6 x 4

- 100MM Piston Grip Air Gun
- Working air pressure 5.0-8.0KGF/CM²
- 1/4"NPT brass tubu joint
- gas flow 1/4" inner weasand:350L/M, 3/8" inner weasand:480L/M
- take eyeshield, earflaps, working gloves and personal protection

Piston Grip Air Gun-250MM Lever



EBS No.	Item No.	pcs-case
1501381	H06402	2 x 8

- 250MM Piston Grip Air Gun
- Working air pressure 5.0-8.0KGF/CM²
- 1/4"NPT brass tubu joint
- gas flow 1/4" inner weasand:350L/M, 3/8" inner weasand:481L/M
- take eyeshield, earflaps, working gloves and personal protection

Gasket Scraper



EBS No.	Item No.	pcs-case
1502585	H62402	4 x 8

- Used for cleaning products surface, and install new seal liner
- also can clean the surface of automatic temperature control pump crank case, timing chain and sealing gasket.

Scraper-Hardwood Handle



EBS No.	Item No.	pcs-case
1501382	H62401	8 x 8

- Heavy Duty Relieving tool scraper knife
- Comfortable Hardwood Handle
- Used for cleaning the mental and engine cover surface

Detecting Screwdriver-6V/12V/24V Car



EBS No.	Item No.	SIZE(mm)	pcs-case
1501871	H07802	6V-12V-24V	12 x 8

- Professional designed for technical transport circuit Faulty.
- Used for Automobile, Motorcyle and earthmriver ircuit Faulty.

Two Way Detecting Screwdriver



EBS No.	Item No.	pcs-case
1501395	H07803	4 x 8

- Used for testing the 6v and 12v circuit voltage and Spark Plug discharging
- Duck Clip connect the ground, detecting needles side connect the ttesting side for test.
- If test the spark plug, use the detect needle to connect to the another side of the handle"

Flexible Magnetic Pickup



EBS No.	Item No.	SIZE(mm)	Scope	pcs-case
1502589	H63002	400	1kg	6 x 8
1502590	H63003	400	2kg	6 x 8
1502591	H63004	400	3kg	6 x 8
1502592	H63005	400	0.5kg	6 x 8

- Acidproof handle
- Long life handle bar, chrome plating, could use in different situation
- Better Powerful magnet, valid adsorption working"

Magnetic Pickup



EBS No.	Item No.	SIZE(mm)	pcs-case
1502588	H63001	380	6 x 20

LED Flexible Magnetic Flashlight



EBS No.	Item No.	pcs-case
1501330	H06006	1 x 20

Panel Clip Pliers



EBS No.	Item No.	pcs-case
1501748	H06003	3 x 8

- Special designed Rivet Pliers, used for car board or others part, such as the rivets in the tire cover plate
- Used to take out the plastic rivets in car body and industrial area use
- Flap nose design, safe for use to take out rivets

H02000 6-Auto Sheet Metal Tool Set (4set/ctn)



- 1-Toe Dolly-Double Domed Face
- 1-Planishing Stake-Reverse Teardrop
- 1-Planishing Stake-Radius Face
- 1-planishing Stake-Zinc Face
- 1-Planishing Hammer-Round & Square Flat Face, 320g Fiberglass Handle
- 1-Planishing Hammer-Round Flat Face & Sharp Head260g Fiberglass Handle

Planishing Hammer-Round & Square Flat Face



EBS No.	Item No.	SIZE	L(mm)	pcs-case
1502401	H48200	320G	330	4 x 8

- High milling steel hammer head, quenching process is not easy to break
- Miniature surface, make the bearing surface evenly
- Special embedded technology, make the hammer head more solid
- Fiberglass handle, the toughness and feeling is good

Planishing Hammer-Round & Square Flat Face



EBS No.	Item No.	SIZE	L(mm)	pcs-case
1502404	H48203	320G	330	4 x 8

- High milling steel hammer head, quenching process is not easy to break
- Miniature surface, make the bearing surface evenly
- Special embedded technology, make the hammer head more solid
- Fiberglass handle, the toughness and feeling is good

Planishing Hammer-Round & Square Flat Face



EBS No.	Item No.	SIZE	L(mm)	pcs-case
1502402	H48201	390G	330	4 x 8

- high milling steel hammer head, quenching process is not easy to break
- miniature surface, make the bearing surface evenly
- Special embedded technology, make the hammer head more solid
- Fiberglass handle, the toughness and feeling is good

Planishing Hammer-Round Flat Face & Sharp Hea



EBS No.	Item No.	SIZE	L(mm)	pcs-case
1502405	H48204	305G	330	4 x 8

- high milling steel hammer head, quenching process is not easy to break
- miniature surface, make the bearing surface evenly
- Special embedded technology, make the hammer head more solid
- Fiberglass handle, the toughness and feeling is good

Planishing Hammer-Round curved Face & Slot Face



EBS No.	Item No.	SIZE	L(mm)	pcs-case
1502403	H48202	305G	330	4 x 8

- high milling steel hammer head, quenching process is not easy to break
- miniature surface, make the bearing surface evenly
- Special embedded technology, make the hammer head more solid
- Fiberglass handle, the toughness and feeling is good

Planishing Hammer-Round Flat Face & Sharp Head



EBS No.	Item No.	SIZE	L(mm)	pcs-case
1502406	H48205	260G	330	4 x 8

- high milling steel hammer head, quenching process is not easy to break
- miniature surface, make the bearing surface evenly
- Special embedded technology, make the hammer head more solid
- Fiberglass handle, the toughness and feeling is good

Toe Dolly-Double Dorned Face

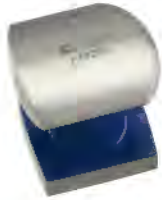

EBS No.	Item No.	SIZE	pcs-case
1502407	H48206	Anvil Dolly	2 x 8

Made of high carbon steel, hot forging, durable for impact

Planishing Stake-Reverse Teardrop



EBS No.	Item No.	SIZE	pcs-case
1502408	H48207	Curved Dilly	2 x 8

Made of high carbon steel, hot forging, durable for impact

Planishing Stake-Radius Face



EBS No.	Item No.	SIZE	pcs-case
1502409	H48208	Toe Dolly	2 x 10

Made of high carbon steel, hot forging, durable for impact

Pry And Bumping Spoon



EBS No.	Item No.	SIZE	pcs-case
1502410	H48209	Pry	2 x 6

Made of high carbon steel, hot forging, durable for impact

Professional Grease Gun



EBS No.	Item No.	SIZE(CC)	PSI	pcs-case
1501758	H06200	100	3000PSI	1 x 12

- 3 usage, 14OZ paperback oil, seal seat, 1000CC bulk oil; high strength kirsite head. For Car, Trunk, ship, Road Roller use. High quality heat treatment spring ensure the balance, special self lock device ensure the security, and convenient. Oil head add steel ball scure the oil not flow back, the withstand voltage for the oil gun is 4500PSI (315KGF/CM²)

Professional Grease Gun



EBS No.	Item No.	SIZE(CC)	PSI	pcs-case
1501759	H06201	400	4500PSI	1 x 12

- 3 usage, 14OZ paperback oil, seal seat, 400CC bulk oil; high strength kirsite head. For Car, Trunk, ship, Road Roller use. High quality heat treatment spring ensure the balance, special self lock device ensure the security, and convenient. Oil head add steel ball scure the oil not flow back, the withstand voltage for the oil gun is 10000PSI (700KGF/CM²)

Professional Grease Gun-Cusion Grip



EBS No.	Item No.	SIZE(CC)	PSI	pcs-case
1501760	H06202	400	4500PSI	1 x 12

- 3 usage, 14OZ paperback oil, seal seat, 400CC bulk oil; high strength kirsite head. For Car, Trunk, ship, Road Roller use. High quality heat treatment spring ensure the balance, special self lock device ensure the security, and convenient. Oil head add steel ball scure the oil not flow back, the withstand voltage for the oil gun is 10000PSI (700KGF/CM²)

Heavy Duty Grease Gun



Accessories:

Hand butter gun oil



Use a butter gun hose



EBS No.	Item No.	SIZE(CC)	PSI	pcs-case
1501761	H06203	600	7000PSI	1 x 10

- High quality iron gun head, special designed for construction machinery and heavy machinery
- Attached with butter soft tube, special for narrow space refuel
- Could add 14OZ paperback oil, seal seat and 60DCC bulk oil
- For Car, Trunk, ship, Road Roller, Paver and Crane use³

High Leverage High Pressure Grease Gun



EBS No.	Item No.	SIZE(CC)	PSI	pcs-case
1501762	H06204	400	8000PSI	1 x 10

- High and low grades transfer swith, convenient for use.
- Patented recycle deflated mouth, ensure no air in the gun tube, smoothly use
- Petented large and small bearing design, High and low grades transfer swith to add oil. Use the high garde to smooth the oil way, then use the low grade to add butter quickly. Improve the working efficiency"

Grease Gun Nozzel

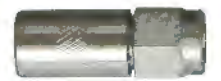

EBS No.	Item No.	pcs-case
1501763	H06211	18 x 4

- Nozzel with steel ball, ensure the oil not flow back

Grease Gun Needle Nozze



EBS No.	Item No.	pcs-case
1501764	H06212	10 x 8

- For special occasion add oil needs

Grease Gun Hos



EBS No.	Item No.	SIZE	L(MM)	pcs-case
1501765	H06213	12"	300	10 x 8
1501766	H06214	18"	450	10 x 8

- High strength nylon sleeve, easy for working



H81144 Air Impact Wrench, 1/2" Dr., Composite Grip Handle



Specification & Features:

- Impact Mechanism: Twin Hammer and imported Japanese steel Drive Shaft
- Forward : 3 Speed. Backward : 1 Speed
- Composite material Handle, light weight
- Downside air outlet Design
- Universal Air inlet joint
- 2.1KG only
- Max torque 1139NM
- easy for single hand operate

Drive: 1/2"
Torque Range(5s): 881 N.m.
Max Torque Range: 1139 N.m.
Free Speed: 9000 RPM
Max Bolt Capacity: M23
Air Inlet: 1/4"

Hose Inner diameter: 3/8"
Average CFM: 5.0 CFM
Air Pressure: 90 Psi
Vibration: 4.6 M/S²
Overall Length: 7-7/8"
Net Weight: 2.1 kg / 4.63 lbs

H81162 Professional Air Impact Wrench, 3/4" Dr., 2034 N.M Max. Torque



Specification & Features:

- Impact Mechanism: TwinHammer
- Gravity Die Casting handle, durable for impact
- Drive Shaft is made of Imported Japanese Steel
- Forward : 3 Speed. Backward : 1 Speed
- Patented machansim design gains more torque
- Downside air outlet Design

Drive: 3/4"
Torque Range(5s): 1627 N.m.
Max Torque Range: 2034 N.m.
Free Speed: 5000 RPM
Max Bolt Capacity: M32
Air Inlet: 3/8"

Hose Inner diameter: 1/2"
Average CFM: 8.4 CFM
Air Pressure: 90 Psi
Vibration: 5.9 M/S²
Overall Length: 8-1/2"
Net Weight: 5.1 kg / 11.24 lbs

H81145 Professional Air Impact Wrench, 1/2" Dr.



Specification & Features:

- Twin Hammer Mechanism , more torque and faster torque output
- Drive Shaft is Made of Imported Japanese Steel
- Forward : 3 Speed. Backward : 1 Speed
- Gravity Die Casting handle
- Downside air outlet Design
- Hot Forging steel front cove

Drive: 1/2"方头
Torque Range(5s): 624 N.m.
Max Torque Range: 745.7 N.m.
Free Speed: 7800 RPM
Max Bolt Capacity: M20
Air Inlet: 1/4"
Hose Inner diameter: 3/8"

Average CFM: 4.47 CFM
Air Pressure: 90 Psi
Vibration: 4.6 M/S²
Sound Pressure: 89 Dba
Overall Length: 7-3/8"
Net Weight: 2.5 kg / 5.51 lbs

H81231 Air Ratchet Wrench, 3/8" Dr., Composite Grip Handle



Specification & Features:

- Cr-Mo Forging ratchet yoke with precision machining and special heat treatment
- Accurate planetary gear running in the Nitrogen treated steel pipe
- Composite Material, aluminum Body

Drive: 3/8"
Max Torque Range: 41 N.m.
Free Speed: 250 RPM
Max Bolt Capacity: 10MM
Air Inlet: 1/4"
Hose Inner diameter: 3/8"

Average CFM: 2.8 CFM
Air Pressure: 90 Psi
Overall Length: 197 MM
Net Weight: 0.6 kg / 1.37 lbs

H81161 Professional Air Impact Wrench, 3/4" Dr.



Specification & Features:

- Impact Mechanism: Twin Hammer and imported Japanese steel Drive Shaft
- Aluminum Handle
- Drive Shaft is made of Imported Japanese Steel
- Front and back push style
- Better weight distribution and airflow design
- High torque/weight cratio, max torque 1356NM
- Hot Forging steel front cover
- more torque and faster torque output

Drive: 3/4"
Torque Range(5s): 1220 N.m.
Max Torque Range: 1356 N.m.
Free Speed: 6300 RPM
Max Bolt Capacity: M24
Air Inlet: 1/4"

Hose Inner diameter: 3/8"
Average CFM: 5.95 CFM
Air Pressure: 90 Psi
Vibration: 6.1 M/S²
Overall Length: 8-1/4"
Net Weight: 4.3 kg / 9.48 lbs

H81241 Air Ratchet Wrench, Industrial Duty 1/2" Dr.



Specification & Features:

- Cr-Mo Forging ratchet yoke with precision machining and special heat treatment
- Accurate planetary gear running in the Nitrogen treated steel pipe

Drive: 1/2"方头
Max Torque Range: 75 N.m.
Free Speed: 160 RPM
Max Bolt Capacity: 3/8"
Air Inlet: 1/4"
Hose Inner diameter: 3/8"

Average CFM: 9 CFM
Air Pressure: 90 Psi
Horsepower: 2 HP
Overall Length: 268 MM
Net Weight: 1.14 kg / 2.51 lbs

GEM-STAR
AIR TOOL



H81131 Professional Air Impact Wrench, 3/8" Dr.



Specification & Features:

- Impact Mechanism: Twin Hammer
- Forward : 3 Speed. Backward : 1 Speed
- Downside air outlet Design
- Forward and backward design, easy to adjust
- Special designed air inlet dial button
- Powerful, Less air Consumption, Stable Torque output

Drive: 3/8"
 Torque Range(5s): 339 N.m.
 Max Torque Range: 393 N.m.
 Free Speed: 10500 RPM
 Max Bolt Capacity: M17
 Air Inlet: 1/4"
 Hose Inner diameter: 3/8"
 Average CFM: 3.0 CFM
 Air Pressure: 90 Psi
 Vibration: 4.9 M/S²
 Overall Length: 6-1/2"
 Net Weight: 1.3 kg / 2.9 lbs

H81142 Air Impact Wrench, 1/2" Dr. ,Composite Grip Handle



Specification & Features:

- Impact Mechanism: Twin Hammer
- Forward : 3 Speed. Backward : 1 Speed
- Downside air outlet Design, Make the air far away from the worker and product
- Composite material Handle, make the weight more light
- Universal Air inlet joint
- Size: 17cm(L) x 16cm(H)

Drive: 1/2"方头
 Torque Range(5s): 678 N.m.
 Max Torque Range: 705 N.m.
 Free Speed: 11000 RPM
 Max Bolt Capacity: M19
 Air Inlet: 1/4"
 Hose Inner diameter: 3/8"
 Average CFM: 4.7 CFM
 Air Pressure: 90 Psi
 Vibration: 4.6 M/S²
 Overall Length: 6-1/4"
 Net Weight: 1.3 kg / 2.87 lbs

H81141 Professional Air Impact Wrench, 1/2" Dr.



Specification & Features:

- Impact Mechanism: Twin Hammer
- Forward and Backward : 5 Speed each
- Downside air outlet Design
- Aluminum Handle, light weight
- More torque and faster torque output
- Ergonomic design

Drive: 1/2"方头
 Torque Range(5s): 623.68 N.m.
 Max Torque Range: 745.7 N.m.
 Free Speed: 7000 RPM
 Max Bolt Capacity: M20
 Air Inlet: 1/4"
 Hose Inner diameter: 3/8"
 Average CFM: 4.27 CFM
 Air Pressure: 90 Psi
 Vibration: 4.6 M/S²
 Overall Length: 7-3/8"
 Net Weight: 2.5 kg / 5.51 lbs

H81143 Air Impact Wrench, Industrial Duty 1/2" Dr.



Specification & Features:

- Impact Mechanism: Twin Hammer
- Forward : 3 Speed. Backward : 2 Speed
- Downside air outlet Design
- Drive Shaft is made of Imported Japanese Steel
- Reinforced impact shaft to extend the lifecycle
- Downside air outlet Design
- Four reinforced connect Bolt to tight and secure the body.

Drive: 1/2"
 Torque Range(5s): 745 N.m.
 Max Torque Range: 881 N.m.
 Free Speed: 8400 RPM
 Max Bolt Capacity: M23
 Air Inlet: 1/4"
 Hose Inner diameter: 3/8"
 Average CFM: 4.71 CFM
 Air Pressure: 90 Psi
 Vibration: 4.6 M/S²
 Overall Length: 8"
 Net Weight: 2.6 kg / 5.7 lbs

Air Tool Instructions:

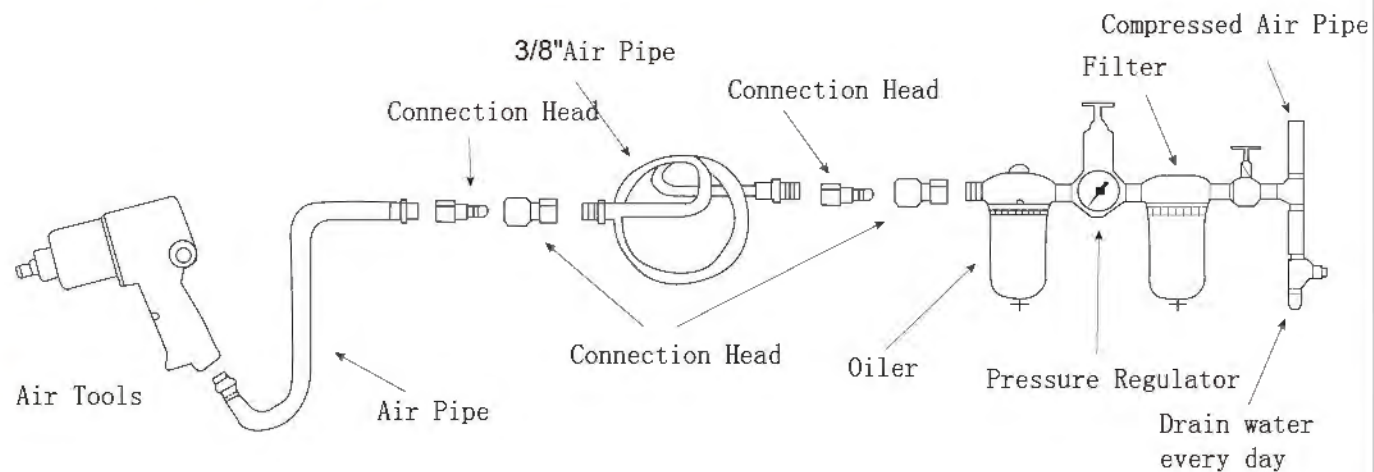

H81421 2" Air Cutting Tools



Air Inlet: 1/4"
 Free Speed: 22000 RPM
 Average CFM: 180 L/Min
 Overall Length: 108 MM
 Net Weight: 0.42kg
 Air Pressure: 90 Psi
 Downside air outlet Design.

H81523 Professional Air Screwdriver, Inline Handle



Specification & Features:

- Impact Mechanism: Twin Hammer
- Suitable for standard screw and hex screw etc.
- Drive shaft and impact component is made of Cr-Mo steel
- Hot foreign Impact component
- Precision casting cylinder

Drive: 1/4" Square
 Drive Capacity: ϕ 2-6mm
 Free Speed: 7000 RPM
 Handle Size: ϕ 46mm
 Hose Inner diameter: 9.5mm
 Average CFM: 0.3 m³/Min
 Overall Length: 185mm
 Net Weight: 0.99 kg / 2.18 lbs

H81631 Air Driller, 3/8" Dr. Reversible, Composite Handle



Specification & Features:

- Composite Material house
- Suitable for drill/grind/enlarge/ream hole
- Composite material Handle
- Fully sealed reversible button
- 3/8" Jacobs Chuck,
- CVT Trigger

Drive: 3/8" Chuck
 Free Speed: 1800 RPM
 Air Inlet: 1/4"
 Hose Inner diameter: 3/8"
 Average CFM: 3.5 CFM
 Air Pressure: 90 Psi
 Sound Pressure: 83 DbA
 Overall Length: 210 mm
 Net Weight: 1.1 kg / 2.43 lbs

H81632 Professional Air Screwdriver, Inline Handle



Specification & Features:

- Suitable for drill/grind/enlarge/ream hole
- Less noisy, light weight, only 1.3kg
- Fully sealed reversible button
- 3/8" Jacobs Chuck
- CVT Trigger

Drive: 3/8" Chuck
 Free Speed: 1800 RPM
 Air Inlet: 1/4"
 Hose Inner diameter: 3/8"
 Average CFM: 0.3 m³/Min
 Air Pressure: 90 Psi
 Horsepower: 3 HP
 Overall Length: 191 mm
 Net Weight: 1.3 kg / 2.86 lbs

H02002 Air Hammer



Specification & Features:
 Cylinder is made of high quality steel, mucg powerful and long lifecycle

Drive: 10MM Round Chuck
 Average CFM: 4 CFM
 Air Pressure: 90 PSI
 Impact per minute: 3200 Min-1
 Air Inlet: 1/4 "-18 NPT
 Overall Length: L7" x H6"
 Net Weight: 1.57kg / 3.46 lbs
 Include:
 Chisel(Round Head): 5pc
 Spring: 2pc



H81321 Straight Die Grinder, 6mm



- Specification & Features:**
- Industrial design and manufacturing, better for plant small batch product and daily maintenance
 - Special casting cylinder
 - Precision elastic chuck

Drive: 6 MM
 Free Speed: 25000 RPM
 Air Inlet: 1/4"
 Hose Inner diameter: 3/8"
 Average CFM: 15 CFM

Air Pressure: 90 PSI
 Overall Length: 140mm
 Net Weight: 0.37 kg / 0.81 lbs

H81322 Air Pencil Grinder



- Specification & Features:**
- Polish the metal on small area and/or corner
 - Eccentric sand grinding design
 - Special eccentric designed mechanism
 - Fully sealed reversable button
 - Single hand dial button suitable easy speed control
 - CVT Trigger

Drive: 3 MM
 Body Length: 135 MM
 Handle Diameter: φ16MM
 Free Speed: 55000 RPM
 Air Inlet: 1/4"

Air Pressure: 90 Psi
 Overall Length: 142 MM
 Net Weight: 0.19kg / 0.42 lbs

H81323 Air Tire Buffer



- Specification & Features:**
- Adjustable wind speed
 - Suitable for small area or narrow space, polish, polish metal, plastic and painting surface etc.
 - Single hand dial button suitable easy speed control
 - CVT Trigger

Drive: 10 MM Hexagon Chuck
 Free Speed: 2600 RPM
 Air Inlet: 1/4"
 Hose Inner diameter: 3/8"
 Average CFM: 4.0 CFM

Air Pressure: 90 Psi
 Horsepower: 0.5 HP
 Overall Length: 225 MM
 Net Weight: 0.8 kg / 1.76 lbs

H81351 3" Composite Air Random Ordital Sander Kits



- Specification & Features:**
- Adjustable wind speed, composite material with light weight
 - Industrial design and manufacturing
 - Special casting cylinder
 - Composite Material house
 - Precision elastic chuck

Pad Diameter: 3" Overall Length: 145mm
 Drive Shaft: 1/4"-20T Net Weight: 1.6 kg / 3.53 lbs
 Free Speed: 16000 RPM
 Air Inlet: 1/4" Specification: Adjustable wind speed, composite material
 Average CFM: 3.5 CFM
 Sound Pressure: 76 Db

Include:
 1Pc 3" Grind Pad
 1Pc 3" Smooth Surface polishing pad
 1Pc 3" Uniform Surface polishing pad
 1Pc 3" Rough Surface polishing pad
 10Pcs Sand paper (#80)
 10Pcs Sand paper (#100)
 10Pcs Sand paper (#120)

H81352 3" Composite Air Random Ordital Sander Kits



- Specification & Features:**
- Adjustable wind speed
 - Polish the metal on small area and/or corner
 - Eccentric sand grinding design
 - Special eccentric designed mechanism
 - Fully sealed reversable button
 - Single hand dial button suitable easy speed control
 - CVT Trigger

Pad Diameter: 3" Overall Length: 125mm
 Drive Shaft: 5/16"-T24 Net Weight: 1.6 kg / 3.53 lbs
 Free Speed: 15000 RPM
 Air Inlet: 1/4" Include:
 Average CFM: 3.5 CFM 1Pc 2" Grind Pad 10Pc 2" Sand paper(#320)
 Sound Pressure: 74 Db 1Pc 3" Grind Pad 10Pc 2" Sand paper(#400)
 10Pc 2" Sand paper(#600)
 10Pc 3" Sand paper(#320)
 10Pc 3" Sand paper(#400)
 10Pc 3" Sand paper(#600)

H81353 3" Composite Air Polisher Kits



- Specification & Features:**
- Adjustable wind speed
 - Suitable for small area or narrow space, polish, polish metal, plastic and painting surface etc.
 - Single hand dial button suitable easy speed control
 - CVT Trigger

Pad Diameter: 3" Overall Length: 135mm
 Drive Shaft: 5/16"-24T Net Weight: 1.6 kg / 3.53 lbs
 Free Speed: 2100 RPM
 Air Inlet: 1/4" Average CFM: 3.5 CFM
 Sound Pressure: 74Db

1Pc 3" Grind Pad
 1Pc 3.5" White foam
 1Pc 3.5" Yellow foam
 1Pc 3.5" wool felt

CYI Air Tool Instructions

1. Must have a alertness before using the tools, especially at the beginning stage.
2. Keep the body in a balance and stable position, when start using the tools, don't close the tool too much. Because the tools will have a high torque reflection under the air pressure.
3. When stop using the tool, the accessories on the tools will still have a short time to work.
4. The tools will vibrate, shaking or turing when using, it may hurt your hand or arm.
5. Use CYI recommend accessories.
6. Only can connect with impact socket and accessories, don't use together with normal socket and accessories.
7. Once finishing using the tools, need to cleaning and lubrication, then store in dry place.
8. Regular check clutch filter.
9. Drain 1.5CC lubricating oil into the oil inlet before starting the air tool and do it again every two hours.
10. Must use the tool in the right way.
11. Please contact Gem-Year maintenance shop near you. The air tool needs to be maintained by skilled.



H81354 5" Composite No Vacuum Air Sander



- Specification & Features:**
- Composite Material house
 - Less vibration
 - Low gravity center design
 - Curved ball bearing shaft with steel cylinder design

Pad Diameter: 5" Air Pressure: 90 Psi
 Free Speed: 10000 RPM Orbit Diameter: 5 MM
 Air Inlet: 1/4" Pad Weight: 100G-120G
 Hose Inner diameter: 3/8" Net Weight: 0.67 kg / 1.48 lbs
 Average CFM: 0.3 M³/Min

H81355 5" Composite Center Vacuum Air Sander



- Specification & Features:**
- Composite Material house
 - Less vibration
 - Low gravity center design
 - Curved ball bearing shaft with steel cylinder design
 - Central dust collection to collect the dust

Pad Diameter: 5" Air Pressure: 90 Psi
 Free Speed: 10000 RPM Orbit Diameter: 5 MM
 Air Inlet: 1/4" Pad Weight: 100G-120G
 Hose Inner diameter: 3/8" Net Weight: 0.77 kg / 1.69 lbs
 Average CFM: 0.3 M³/Min

H81356 5" Angular Air Grinder



- 特色:**
- Professional Tools, 5" grinding wheel
 - Cr-Mo steel vortex bevel gear, with special heat treatment
 - Metro coaxial Design can control the motor accurate

Wheel Diameter: 5" Overall Length: 8-7/8"
 Free Speed: 11000 RPM Net Weight: 1.82 kg / 4.01 lbs
 Air Inlet: 1/4" Include one Grinding Wheel
 Hose Inner diameter: 3/8"
 Average CFM: 6 CFM



H81711 Air Nailer, 32-60MM



Specification & Features:
 Nail Type: Wire nail, Steel nail, Screw nail
 Special construction design, safety for using.

Nail Diameter: 2.1-2.5mm Net Weight: 2.5kg
 Nail Length: 32-60mm
 Load Quantity: 350pc
 Operation Pressure: 100-120psi
 Size: 270*130*270mm

H81712 Air Nailer, 38-70MM



Specification & Features:
 Nail Type: Wire nail, Steel nail, Screw nail
 Special construction design, safety for using

Nail Diameter: 2.3-2.9mm Net Weight: 3.5kg
 Nail Length: 38-70mm
 Load Quantity: 250-300pc
 Operation Pressure: 100-120 psi
 Size: 300*130*360mm

H81713 Air Nailer, 50-90MM



Specification & Features:
 Nail Type: Wire nail, Steel nail, Screw nail
 Special construction design, safety for using

Nail Diameter: 2.5-3.3mm Net Weight: 3.7kg
 Nail Length: 50-90mm
 Load Quantity: 225-300pc
 Operation Pressure: 100-120psi
 Size: 300*130*380mm

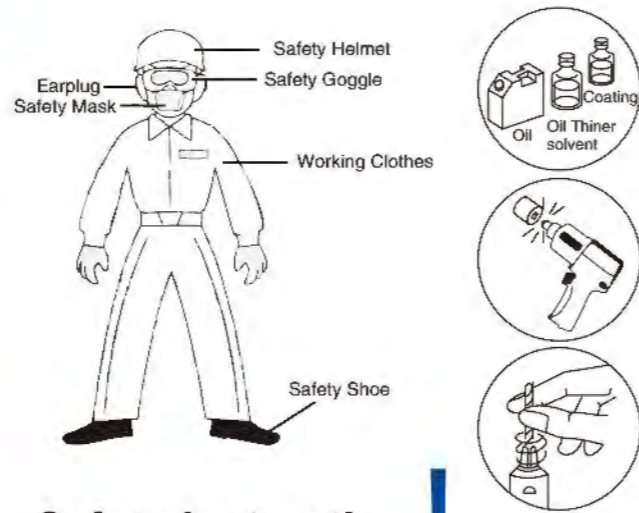

Safety Instruction

1. Must dress the professional clothes during the work period
 Once use the tool, need to dress tight cuff, and don't wear any jewelry, necklace, scarf and so on, also need to keep a short distance with the tools.
2. Must wear safety protectors during the work period
 According to the working environment, must dress the safety glass, safety clothes, earplug and so on to prohibit the tools hurt the work.
3. People without entry commission can not close the work space
 People without entry commission can not entry the work space, especially for the children.
4. Keep the working environment clean and brightness
 The working space must be bright enough, the tools should be displayed well, and work place should be cleaned everyday.
5. Work posture must be correct
 Use wrong work posture may make yourself in dangerous situation.
6. Don't Touch the tool operation and vibration part
 Don't Touch the rotating or impact component, to prevent the tools hurt your hand.
7. Air tool can not work close the dangerous situation
 Air tool may cause fire, especially for the sand grind working, so must far away from the oil, gas, panting once using.
8. Must Separate the air pipe before changing the tool head accessories
 If work too careless, it may hurt the working person.
9. Unprofessional person can not separate or change the tools construction
 Unprofessional person can not separate the or change the tool construction, also can not change the interior part. Because it not only will hurt the product, but also will hurt the people.
10. Must check the accessories for the air tools head is tight
 Before using the tool, much check the accessories on the air tool head is firm or not and the screw is loose or not.

H02213 1501542

12pcs 12.5MM Dr Impact Socket Set (6set/ctn)



- 10pcs 12.5mm DR. Impact Socket (Metric) (10, 11, 12, 13, 14, 17, 19, 21, 22, 23, 24MM)
- 1pc 12.5mm Dr. Impact Universal Joint
- 1pc 12.5mm Dr. Impact Extension Bar

6.3MM Dr Impact Adaptor (METRIC)



EBS No.	Item No.	SIZE(mm)	pcs-case
1501316	H28990	3/8"×1/4(M×F)	12 x 48

• Made of CR-Mo high stress steel, cold forging, durable for impact

10MM DR. Impact Socket (Metric)



EBS No.	Item No.	SIZE(mm)	pcs-case
1500523	H28150	7	6 x 48
1500524	H28151	8	6 x 48
1500525	H28152	9	6 x 48
1500526	H28153	10	6 x 48
1500527	H28154	11	6 x 48
1500528	H28155	12	6 x 48
1500529	H28156	13	6 x 48
1500530	H28157	14	6 x 48
1500531	H28158	15	6 x 27
1500532	H28159	16	6 x 27
1500533	H28160	17	6 x 27
1500534	H28161	18	6 x 24
1500535	H28162	19	6 x 24

• Made of CR-Mo high stress steel, cold forging, durable for impact

10MM Dr. Impact Universal Joint (METRIC)



EBS No.	Item No.	SIZE(mm)	pcs-case
1501407	H28920	52	4 x 36

• Made of CR-Mo high stress steel, cold forging, durable for impact

10MM DR. Impact Deep Socket (Metric)



EBS No.	Item No.	SIZE(mm)	pcs-case
1501306	H28250	7	6 x 27
1500536	H28251	8	6 x 27
1500537	H28252	9	6 x 27
1500538	H28253	10	6 x 27
1500539	H28254	11	6 x 27
1500540	H28255	12	6 x 27
1500541	H28256	13	6 x 27
1500542	H28257	14	6 x 27
1500543	H28258	15	6 x 16
1500544	H28259	16	6 x 16
1500545	H28260	17	6 x 16
1500546	H28261	18	6 x 12
1500547	H28262	19	6 x 12

• Made of CR-Mo high stress steel, cold forging, durable for impact

12.5MM Dr. Impact Adaptor (METRIC)



EBS No.	Item No.	SIZE(mm)	pcs-case
1501313	H28940	1/2"×3/8(M×F)	6 x 6
1501314	H28941	1/2"×3/4(M×F)	6 x 16

• Made of CR-Mo high stress steel, cold forging, durable for impact

12.5MM Dr. Impact Universal Joint (METRIC)



EBS No.	Item No.	SIZE(mm)	pcs-case
1501315	H28950	1/2"×1/2(M×F)	4 x 16

• Made of CR-Mo high stress steel, cold forging, durable for impact

12.5MM Dr. Impact Extension Bar (METRIC)



EBS No.	Item No.	SIZE(mm)	pcs-case
1501312	H28934	3	6 x 16
1501408	H28930	5	6 x 18
1501307	H28931	6	6 x 18
1501310	H28932	10	4 x 8
1501311	H28933	12	4 x 6

• Made of CR-Mo high stress steel, cold forging, durable for impact

12.5MM DR. Impact Socket(Metric)



EBS No.	Item No.	SIZE(mm)	pcs-case
1500548	H28350	10	6 x 27
1500549	H28351	11	6 x 27
1500550	H28352	12	6 x 27
1500551	H28353	13	6 x 27
1500552	H28354	14	6 x 27
1500553	H28355	15	6 x 27
1500554	H28356	16	6 x 27
1500555	H28357	17	6 x 27
1500556	H28358	18	4 x 27
1500557	H28359	19	4 x 27
1500558	H28360	21	4 x 27
1500559	H28361	22	4 x 27
1500560	H28362	23	4 x 24
1500561	H28363	24	4 x 24
1500562	H28364	27	4 x 24
1501401	H28365	29	2 x 30
1500563	H28366	30	2 x 30
1500564	H28367	32	2 x 30

• Made of CR-Mo high stress steel, cold forging, durable for impact

12.5MM DR. Impact Deep Socket(Metric)



EBS No.	Item No.	SIZE(mm)	pcs-case
1500565	H28450	10	6 x 16
1500566	H28451	11	6 x 16
1500567	H28452	12	6 x 16
1500568	H28453	13	6 x 16
1500569	H28454	14	6 x 16
1500570	H28455	15	6 x 16
1500571	H28456	16	6 x 16
1500572	H28457	17	6 x 16
1500573	H28458	18	6 x 12
1500574	H28459	19	4 x 16
1500575	H28460	21	4 x 16
1500576	H28461	22	4 x 16
1500577	H28462	24	4 x 12
1501402	H28463	26	4 x 12
1500578	H28464	27	4 x 12
1501403	H28465	29	2 x 16
1500579	H28466	30	2 x 16
1500580	H28467	32	2 x 16

• Made of CR-Mo high stress steel, cold forging, durable for impact

19MM DR. Impact Socket(Metric)



EBS No.	Item No.	SIZE(mm)	pcs-case
1504196	H28550	17	7 x 8
1504197	H28551	18	7 x 8
1504198	H28552	19	7 x 8
1504199	H28554	21	7 x 8
1504200	H28555	22	7 x 8
1504201	H28557	24	7 x 8
1504202	H28560	27	7 x 8
1504203	H28563	30	7 x 6
1504204	H28565	32	6 x 6
1504205	H28566	33	6 x 6
1504206	H28567	34	6 x 6
1504207	H28569	36	4 x 8
1504208	H28573	40	4 x 8
1504209	H28574	41	3 x 8
1504210	H28575	42	3 x 8
1504211	H28579	46	3 x 8
1504212	H28583	50	3 x 8
1504213	H28586	55	2 x 8
1504214	H28593	65	2 x 8

• Made of CR-Mo high stress steel, cold forging, durable for impact

19MM DR. Impact Deep Socket(Metric)



EBS No.	Item No.	SIZE(mm)	pcs-case
1504215	H28652	19	5 x 4
1504216	H28655	22	5 x 4
1504217	H28657	24	5 x 4
1504218	H28660	27	5 x 4
1504219	H28663	30	5 x 4
1504220	H28665	32	4 x 4
1504221	H28667	34	3 x 6
1504222	H28669	36	3 x 6
1504223	H28673	41	2 x 8
1504224	H28678	46	2 x 8
1504225	H28682	50	2 x 8
1504226	H28683	55	2 x 8

• Made of CR-Mo high stress steel, cold forging, durable for impact

19MM Dr. Impact Extension Bar (METRIC)



EBS No.	Item No.	SIZE(mm)	pcs-case
1504227	H28961	4"	3 x 8
1504228	H28964	8"	2 x 8
1504229	H28965	10"	2 x 6

• Made of CR-Mo high stress steel, cold forging, durable for impact

10MM Dr Impact Adaptor (METRIC)



EBS No.	Item No.	SIZE(mm)	pcs-case
1501406	H28910	3/8"×1/2(M×F)	6 x 48

• Made of CR-Mo high stress steel, cold forging, durable for impact

12.5MMDr. Impact Universal Joint (METRIC)



EBS No.	Item No.	SIZE(mm)	pcs-case
1501315	H28950	3/4"×3/4(M×F)	4 x 16

• Made of CR-Mo high stress steel, cold forging, durable for impact

10MM Dr. Impact Extension Bar (METRIC)



EBS No.	Item No.	SIZE(mm)	pcs-case
1501404	H28900	3	8 x 24
1501405	H28901	6	8 x 18

• Made of CR-Mo high stress steel, cold forging, durable for impact

19MM Dr Impact Adaptor (METRIC)



EBS No.	Item No.	SIZE(mm)	pcs-case
1504230	H28970	3/4"×1/2(M×F)	9 x 6

• Made of CR-Mo high stress steel, cold forging, durable for impact

19MMDr. Impact Universal Joint (METRIC)



EBS No.	Item No.	SIZE(mm)	pcs-case
1504231	H28980	3/4"×3/4(M×F)	3 x 8

• Made of CR-Mo high stress steel, cold forging, durable for impact



NEW

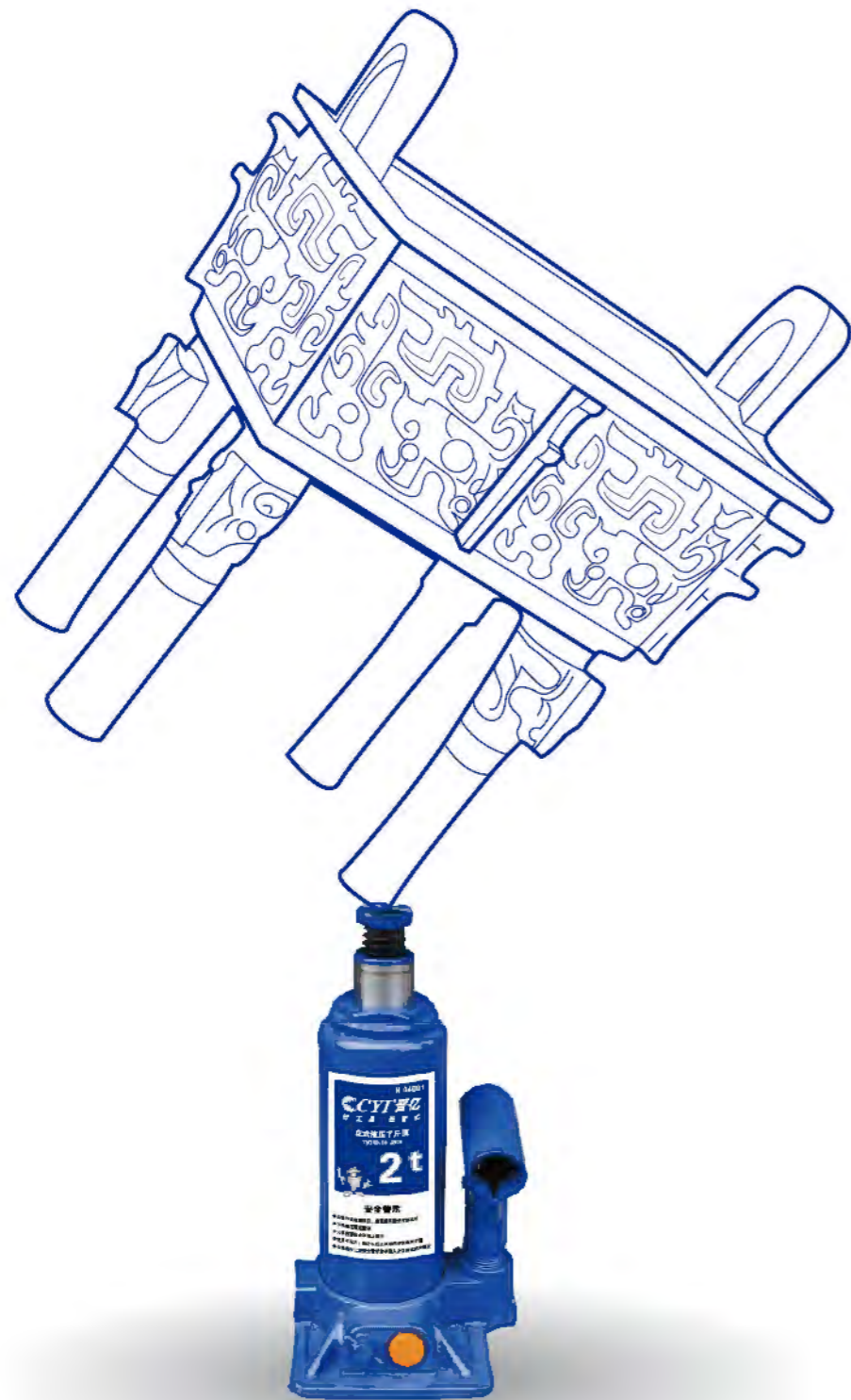

Power · Safety

- ◆ In order to ensure the safety value, each Hydraulic Jack will have a 1.25 times of the standard overload test, only pass the test, then the Hydraulic Jack could sell to the market.(P.S. The overload test is proceed in the laboratory, pls don't overload use in reality.)
- ◆ Strictly according to the GB/T 27697-2011 Standard

Power · Safety



- ◆ All the Tons which marked on the Hydraulic Jack is metric ton, not short ton. (1 metric = 1.1 short ton)
- ◆ In order to ensure the safety value, the actually load weight should be lower or same as the marked weight on the product.
- ◆ In order to ensure the safety value, when the weight reach the 1.15 times of the standard, the safety valve will start with stop to increase the load weight automatically.
- ◆ Chrome plated piston and piston pump reinforce the strength and durability.
- ◆ Use lower-freezing hydraulic oil, the working temperature range is -20℃-45℃
- ◆ Strictly according to the GB/T 27697-2011 Standard

Heavy Duty Hydraulic Bottle Jack



Item NO.	Specification (metric)	Max Weight	Product Weight	Min Height	Start Height	Adjust Height	Max Height
H04001	2	2000	2.2	158MM	90MM	60MM	308MM
H04002	4	4000	3.1	195MM	125MM	60MM	380MM
H04003	6	6000	4.0	197MM	125MM	60MM	382MM
H04004	8	8000	4.8	205MM	125MM	60MM	390MM
H04005	10	10000	5.4	205MM	125MM	60MM	390MM
H04006	16	16000	7.7	225MM	140MM	60MM	425MM
H04007	20	20000	10.5	244MM	145MM	60MM	449MM
H04008	32	32000	19.0	285MM	180MM	-	465MM
H04009	50	50000	30.0	300MM	180MM	-	480MM

Specification & Features

- ◆ All the Tons which marked on the Hydraulic Jack is metric ton, not short ton. (1 metric = 1.1 short ton)
- ◆ In order to ensure the safety value, the actually load weight should be lower or same as the marked weight on the product.
- ◆ In order to ensure the safety value, when the weight reach the 1.15 times of the standard, the safety valve will start with stop to increase the load weight automatically.
- ◆ Chrome plated piston and piston pump reinforce the strength and durability.
- ◆ Use lower-freezing hydraulic oil, the working temperature range is -20℃-45℃
- ◆ Strictly according to the GB/T 27697-2011 Standard

Heavy Duty Hydraulic Service Jack



Item NO.	Specification	Max Weight	Product Weight	Min Height	Start Height	Size
H04015	1.5	1500	6.8	125MM	300MM	418x191x125MM
H04016	2	2000	8.7	135MM	335MM	448x200x135MM

- ◆ All the Tons which marked on the Hydraulic Jack is metric ton, not short ton. (1 metric = 1.1 short ton)
- ◆ In order to ensure the safety value, the actually load weight should be lower or same as the marked weight on the product.
- ◆ In order to ensure the safety value, when the weight reach the 1.15 times of the standard, the safety valve will start with stop to increase the load weight automatically.
- ◆ Chrome plated piston and piston pump reinforce the strength and durability.
- ◆ Use lower-freezing hydraulic oil, the working temperature range is -20℃-45℃
- ◆ Strictly according to the GB/T 27697-2011 Standard

Jack Stands 3T



Item NO.	Specification (metric)	Max Weight	Start Height	Product Weight	Min Height	Max Height
H04031	3	3000	141MM	7	287MM	428MM





High Speed Railway System Fasteners



Product Size: WJ7, WJ8, Type 3, Type 4
Material: Carbon Steel, Alloy Steel

Motorcycle Fasteners



Product Size: M3-M20
Material: Carbon Steel, Alloy Steel, Stainless Steel

Furniture Fasteners



Product Size: M3-M24
Material: Carbon Steel, Alloy Steel, Stainless Steel

Automobile Fasteners



Product Size: M3-M30
Material: Carbon Steel, Alloy Steel, Stainless Steel

Bicycle Fasteners



Product Size: M3-M16
Material: Carbon Steel, Alloy Steel, Stainless Steel

Non-Standard Fasteners



Product Size: M3-M100
Material: Carbon Steel, Alloy Steel, Stainless Steel

Precision Wire



Product Size: M1.6-M38
Material: Carbon Steel, Alloy Steel, Stainless Steel

Engine Fasteners



Product Size: M3-M30
Material: Carbon Steel, Alloy Steel, Stainless Steel

Household Electrical Fasteners



Product Size: M3-M30
Material: Carbon Steel, Alloy Steel, Stainless Steel

Gypsum Board Nails



Product Size: M3-M6.3
Material: Carbon Steel, Alloy Steel, Stainless Steel



Common Fasteners



Product Size: M3-M100
Material: Carbon Steel, Alloy Steel, Stainless Steel

Nails

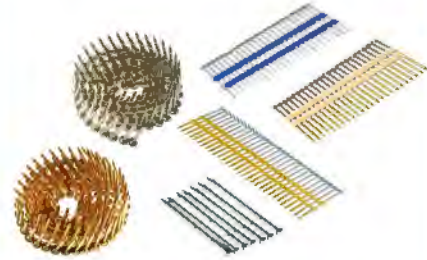

Product Discription: Volume Nail, Row Nail, Lose Nail
Material: Carbon Steel, Alloy Steel, Stainless Steel

Highway Fasteners



Product Size: M10-M30
Material: Carbon Steel, Alloy Steel, Stainless Steel

Other Common Fasteners



Product Size: M3-M100
Material: Carbon Steel, Alloy Steel, Stainless Steel

Steel Fasteners



Product Size: M5-M60
Material: Carbon Steel, Alloy Steel, Stainless Steel

Electrical Fasteners



Product Size: M3-M100
Material: Carbon Steel, Alloy Steel, Stainless Steel

Decorative Nails



Product Size: M2-M8
Material: Carbon Steel, Alloy Steel, Stainless Steel

Railway System Fasteners



Product Size: M10-M36
Material: Carbon Steel, Alloy Steel, Stainless Steel

Nuclear Fasteners



Product Size: M3-M100
Material: Carbon Steel, Alloy Steel, Stainless Steel

Other Fasteners



Other Fasteners



Other Fasteners



Other Fasteners



Other Fasteners



Other Fasteners



产品编号	货号	订货号	页码	产品编号	货号	订货号	页码	产品编号	货号	订货号	页码	产品编号	货号	订货号	页码
H01000	03710	1500003	81	H02211	09268	1501540	83	H02809	03860	1501304	69	H05620	-	1501699	38
H01001	03720	1500004	81	H02212	09267	1501541	83	H02810	03870	1501305	69	H05621	-	1501700	38
H01002	03760	1500005	81	H02213	09009	1501542	114	H02811	03880	1501328	69	H05622	-	1501701	38
H01003	04110	1500006	4	H02214	09521	1501543	17	H02812	03901	1501606	64	H05623	-	1501702	38
H01004	06003	1500007	4	H02216	09523	1501544	17	H02813	03902	1501607	64	H05632	-	1501710	38
H01005	06008	1500008	3	H02218	09525	1501545	17	H02814	03903	1501608	65	H05633	-	1501711	38
H01006	09011	1500009	3	H02300	09020	1500026	29	H02815	03904	1501609	65	H05634	-	1501712	38
H01007	09013	1500010	2	H02301	09022	1500027	29	H03100	95107	1500046	9	H05635	-	1501713	38
H01008	09014	1500011	2	H02302	09026	1500028	30	H03101	95109	1500047	9	H05636	-	1501714	38
H01009	09510	1500012	2	H02303	09028	1500029	30	H03102	95119	1500048	10	H05637	-	1501715	38
H01010	09518	1500013	98	H02304	09029	1500030	30	H03103	-	1500049	11	H05638	-	1501716	38
H01011	09535	1500014	81	H02305	09040	1500031	29	H03104	-	1500050	10	H05639	-	1501717	38
H01013	09509	1501481	98	H02306	09045	1500032	30	H03200	95101	1500054	11	H05640	-	1501718	38
H01014	09516	1501482	3	H02307	09046	1500033	30	H03201	95102	1500055	11	H05641	-	1501719	38
H01015	09536	1501483	83	H02308	-	1500034	30	H03202	95103A	1500056	11	H05642	-	1501720	38
H01017	06001	1501484	4	H02309	09027	1501383	31	H03203	95115	1501610	11	H05643	-	1501721	38
H01018	06002	1501485	4	H02310	08010	1501546	31	H03230	95116	1501611	12	H05644	-	1501722	38
H01019	09014A	1501486	98	H02311	08012	1501547	31	H03231	95117	1501612	12	H05645	-	1501723	38
H01020	06004	1501487	5	H02312	08008	1501420	29	H03250	95104A	1501613	12	H05646	-	1501724	38
H01021	06005	1501488	5	H02313	08009	1501548	31	H03251	-	1501614	12	H05647	-	1501725	38
H01022	06011	1501489	5	H02315	09025	1501421	29	H03261	03601	1501345	12	H05648	-	1501726	38
H01023	03750	1501490	82	H02316	09041	1501422	29	H03262	03621	1501615	12	H05649	-	1501727	38
H01024	03780	1501491	82	H02317	09042	1501423	29	H03301	95193	1501621	13	H05650	-	1501728	38
H01025	09551	1501492	5	H02321	08011	1501549	31	H03302	95198	1500057	13	H05651	-	1501729	38
H02000	09152	1501493	104	H02323	09034	1501550	29	H03303	95181	1501622	13	H05652	-	1501730	38
H02001	09251	1501494	57	H02324	09037	1501551	29	H03304	95182	1501623	12	H05653	-	1501731	38
H02003	09531	1501496	101	H02326	09012	1501552	30	H03305	95183	1501624	13	H05659	-	1501737	38
H02004	09703	1501497	99	H02327	09031	1501553	30	H03306	95184	1501625	13	H05660	-	1501738	38
H02005	09406	1501343	103	H02400	-	1500035	40	H03307	95185	1501626	13	H05661	-	1501739	38
H02006	09410	1501498	99	H02401	09101	1500036	40	H03308	95186	1501627	12	H05662	-	1501740	38
H02007	09411	1501344	102	H02402	09102	1501555	40	H03309	95187	1501628	12	H05663	-	1501741	38
H02008	09412	1501499	99	H02403	09103	1500037	40	H03310	95188	1501629	12	H05664	-	1501742	38
H02009	09413	1501500	99	H02404	09104	1501556	40	H03401	95211	1501631	13	H05665	-	1501743	38
H02010	09706	1501501	99	H02405	09105	1500038	40	H03402	95212	1501632	13	H05666	-	1501744	38
H02011	09712	1501502	99	H02406	09106	1501557	40	H03403	95213	1501633	13	H05667	-	1501745	38
H02012	09261	1501503	53	H02407	09107	1500039	40	H03404	95215	2600045	13	H06001	97501	1501746	103
H02013	09262	1501504	53	H02408	09108	1501558	41	H04001	-	1501634	118	H06002	97502	1501747	103
H02021	02021	1501505	89	H02410	09701	1501561	41	H04002	-	1501635	118	H06003	09408	1501748	104
H02022	02022	1501506	89	H02411	09702	1501562	41	H04003	-	1501636	118	H06004	90654	1501749	103
H02023	02023	1501507	89	H02412	-	1504032	42	H04004	-	1501637	118	H06005	97101	1501329	101
H02024	02024	1501508	89	H02413	-	1504033	42	H04005	-	1501638	118	H06006	-	1501330	104
H02025	02025	1501509	89	H02414	09119	1501565	41	H04006	-	1501639	118	H06011	97701	1501750	100
H02026	02026	1501510	89	H02415	09121	1501566	41	H04007	-	1501640	118	H06012	97702	1501751	100
H02027	02027	1501511	89	H02417	09123	1501568	41	H04008	-	1501641	118	H06200	97201	1501758	106
H02028	02028	1501512	89	H02418	09115	1501569	40	H04009	-	1501642	118	H06201	97202	1501759	106
H02031	09811	1600063	96	H02419	09113	1501570	40	H04015	-	1501647	118	H06202	97203	1501760	106
H02032	09812	1501514	96	H02421	-	1501572	40	H04016	-	1501648	118	H06203	97204	1501761	106
H02033	09813	1501515	96	H02422	-	1501573	40	H04031	-	1501650	118	H06204	97205	1501762	106
H02041	-	1501516	89	H02423	-	1501574	41	H05121	-	1501652	36	H06211	97211	1501763	106
H02042	-	1501517	89	H02424	-	1501575	41	H05131	-	1501653	36	H06212	97216	1501764	106
H02043	-	1501518	89	H02500	09301A	1500043	44	H05141	-	1501654	36	H06213	97212	1501765	106
H02044	-	1501519	89	H02501	09306	1500044	44	H05142	-	1501655	36	H06214	97213	1501766	106
H02045	-	1501520	89	H02502	09309	1500045	44	H05143	-	1501656	36	H06301	97401	1501238	103
H02046	-	1501521	89	H02503	09305	1501578	44	H05161	-	1501657	36	H06302	97403	1501239	103
H02047	-	1501522	89	H02511	03141	1501580	86	H05162	-	1501658	36	H06303	97404	1501240	103
H02048	-	1501523	89	H02512	03142	1501581	86	H05163	-	1501659	36	H06304	97405	1501241	103
H02101	09901	1501524	6	H02513	-	1501582	87	H05331	-	1501664	36	H06305	97406	1501242	103
H02102	09902	1501525	6	H02514	-	1501583	87	H05341	-	1501665	36	H06306	97407	1501243	103
H02103	09903	1501526	6	H02515	-	1501584	87	H05342	-	1501666	36	H06321	97422	1501767	102
H02104	09904	1501527	6	H02516	-	1501585	87	H05343	-	1501667	36	H06322	97426	1501768	102
H02105	09905	1501528	6	H02517	09317	1501586	87	H05361	-	1501668	36	H06323	97427	1501769	102
H02106	09906	1501529	6	H02518	-	1501587	87	H05362	-	1501669	36	H06324	97428	1501770	102
H02107	09907	1501530	7	H02519	-	1501588	88	H05431	-	1501671	37	H06325	97441	1501771	102
H02108	09908	1501531	7	H02520	09301A	1501589	44	H05441	-	1501672	37	H06401	97221	1501380	104
H02109	09909	1501532	7	H02521	-	1503075	48	H05442	-	1501673	37	H06402	97222	1501381	104
H02111	09911	1501534	7	H02522	-	1503073	48	H05443	-	1501674	37	H06501	97619	1501415	101
H02113	09913	1501536	7	H02601	-	1501592	48	H05461	-	1501676	37	H06502	97102	1501772	101
H02114	09914	1501537	7	H02602	-	1501593	48	H05501	-	1501678	37	H06503	97103	1501773	101
H02115	09915	1501538	7	H02603	-	1501594	48	H05502	-	1501679	37	H06504	97104	1501774	101
H02200	09001	1500016	15	H02611	09331	1501595	48	H05601	-	1501687	37	H06600	97521	1501775	104
H02201	09002	1500017	15	H02612	09332	1501596	48	H05602	-	1501688	37	H06601	97512	1501776	103
H02202	09004	1500018	15	H02613	09333	1501346	48	H05611	-	1501690	38	H06602	97511	1501777	102
H02203	09005	1500019	15	H02801	03801	1501601	67	H05612	-	1501691	38	H06701	90651	1501778	100
H02204	09006	1500020	15	H02802	03802	1501602	67	H05613	-	1501692	38	H06702	90652	1501779	100
H02205	09007	1500021	15	H02803	03803	1501603	67	H05614	-	1501693	38	H06703	90653	1501780	100
H02206	09015	1500022	16	H02804	03804	1501604	67	H05615	-	1501694	38	H06711	90661	1501781	100
H02207	09053	1500023	16	H02805	03805	1501605	67	H05616	-	1501695	38	H06712	90662	1501782	100
H02208	09099	1500024	16	H02806	03810	1501301	67	H05617	-	1501696	38	H06713	90663	1501783	100
H02209	-	1500025	16	H02807	03830	1501302	68	H05618	-	1501697	38	H06714	90664	1501784	100
H02210	09526														

产品编号	货号	订货号	页码	产品编号	货号	订货号	页码	产品编号	货号	订货号	页码	产品编号	货号	订货号	页码
H22215	12316	1500216	19	H23149	13510	1500289	21	H23502	13703	1500368	22	H26100	22504	1500439	26
H22216	12317	1500217	19	H23150	13511	1500290	21	H23503	13704	1500369	22	H26101	22501	1500440	26
H22217	12318	1500218	19	H23151	13512	1500291	21	H23504	13705	1500370	22	H26102	22502	1500441	26
H22300	12201	1500219	19	H23152	13513	1500292	21	H23505	13706	1500371	22	H26103	22503	1500442	26
H22301	12202	1500220	19	H23153	13514	1500293	21	H23506	13707	1500372	22	H26200	22301	1500443	26
H22302	12203	1500221	19	H23154	13515	1500294	21	H23507	13708	1500373	22	H26201	22302	1500444	26
H22303	12204	1500222	19	H23200	13319	1500295	21	H23530	13915	1500374	101	H26202	22303	1500445	26
H22304	12205	1500223	19	H23201	13320	1500296	21	H23531	13916	1500375	101	H26300	22101	1500446	26
H22305	12206	1500224	19	H23202	13301	1500297	21	H23900	-	1502018	22	H26301	22102	1500447	26
H22306	12207	1500225	19	H23203	13302	1500298	21	H23901	13902	1500376	22	H26302	22103	1500448	26
H22307	12208	1500226	19	H23204	13303	1500299	21	H23902	13901	1501400	22	H26303	22104	1500449	26
H22308	12209	1500227	19	H23205	13304	1500300	21	H23910	13904	1500377	22	H26304	22105	1500450	26
H22400	12401	1500228	20	H23206	13305	1500301	21	H23911	13905	1500378	22	H26305	22106	1500451	26
H22401	12402	1500204	20	H23207	13306	1500302	21	H23913	-	1502021	22	H26306	22107	1500452	26
H22402	12403	1500229	20	H23208	13307	1500303	21	H23914	-	1502022	22	H26307	22108	1500453	26
H22403	12404	1500230	20	H23209	13308	1500304	21	H23920	13909	1500379	22	H26308	22109	1500454	26
H22404	12405	1500231	20	H23210	13309	1500305	21	H23921	13911	1500380	22	H26309	22110	1500455	26
H22405	12406	1500232	20	H23211	13310	1500306	21	H23930	13910	1500381	22	H26310	22111	1500456	26
H22406	12407	1500233	20	H23212	13311	1500307	21	H23950	13914	1500382	23	H26400	22201	1500457	26
H22407	12408	1500234	20	H23213	13312	1500308	21	H23951	13913	1500383	23	H26401	22202	1500458	26
H22408	12409	1500235	20	H23214	13313	1500309	21	H23953	13930	1500384	23	H26402	22203	1500459	26
H22409	12410	1500236	20	H23215	13314	1500310	21	H23955	-	1502025	100	H26403	22204	1500460	26
H22410	12411	1500237	20	H23216	13315	1500311	21	H23956	-	1502026	100	H26404	22205	1500461	26
H22411	12412	1500238	20	H23217	13316	1500312	21	H23960	13912	1500385	22	H26405	22206	1500462	26
H22500	12701	1500239	20	H23218	13317	1500313	21	H23980	13919	1501397	23	H26406	22207	1500463	26
H22501	12702	1500240	20	H23219	13318	1500314	21	H23981	13920	1502027	101	H26500	22401	1500464	26
H22502	12703	1500241	20	H23220	-	1502017	21	H23990	17001	1500386	23	H26501	22402	1500465	26
H22503	12704	1500242	20	H23240	13619	1500315	22	H24240	16602	1500387	23	H26502	22403	1500466	26
H22504	12705	1500243	20	H23241	13620	1500316	22	H24241	16603	1500388	23	H26600	22601	1500467	27
H22505	12706	1500244	20	H23242	13601	1500317	22	H24242	16604	1500389	23	H26601	22602	1500468	27
H22506	12707	1500245	20	H23243	13602	1500318	22	H24243	16605	1500390	23	H26602	22603	1500469	27
H22507	12708	1500246	20	H23244	13603	1500319	22	H24244	16606	1500391	23	H26603	22604	1500470	27
H22508	12709	1500247	20	H23245	13604	1500320	22	H24245	16607	1500392	23	H27310	24101	1500471	27
H22509	12710	1500248	20	H23246	13605	1500321	22	H24246	16608	1500393	23	H27311	24102	1500472	27
H22510	12711	1500249	20	H23247	13606	1500322	22	H24247	16609	1500394	23	H27312	24103	1500473	27
H22511	12712	1500250	20	H23248	13607	1500323	22	H24248	16610	1500395	23	H27313	24104	1500474	27
H22512	12713	1500251	101	H23249	13608	1500324	22	H24249	16611	1500396	23	H27314	24105	1500475	27
H22513	12714	1500252	101	H23250	13609	1500325	22	H24250	16612	1500397	23	H27315	24106	1500476	27
H22900	-	1502007	20	H23251	13610	1500326	22	H24251	16613	1500398	23	H27316	24107	1500477	27
H22901	12902	1500253	20	H23252	13611	1500327	22	H24252	16614	1500399	23	H27317	24108	1500478	27
H22902	12901	1501399	20	H23253	13612	1500328	22	H24253	16615	1500400	23	H27318	24109	1500479	27
H22910	12903	1500254	20	H23254	13613	1500329	22	H24254	16616	1500401	23	H27320	25101	1500480	27
H22911	12904	1500255	20	H23255	13614	1500330	22	H24255	16617	1500402	23	H27321	25102	1500481	27
H22912	12905	1500256	20	H23256	13615	1500331	22	H24256	16618	1500403	23	H27322	25103	1500482	27
H22915	-	1502010	20	H23257	13616	1500332	22	H24257	16619	1500404	23	H27323	25104	1500483	27
H22916	-	1502011	20	H23258	13617	1500333	22	H24258	16620	1500405	23	H27324	25105	1500484	27
H22917	-	1502012	20	H23259	13618	1500334	22	H24259	16621	1500406	23	H27325	25106	1500485	27
H22920	12909	1500257	20	H23300	13201	1500335	21	H24260	16623	1500407	23	H27326	25107	1500486	27
H22930	12910	1500258	20	H23301	13202	1500336	21	H24261	16624	1500408	23	H27327	25108	1500487	27
H22950	12917	1500259	20	H23302	13203	1500337	21	H24900	16901	1500409	23	H27328	25109	1500488	27
H22951	12913	1500260	20	H23303	13204	1500338	21	H24910	16902	1500410	24	H27410	24201	1500489	27
H22952	12914	1500261	20	H23304	13205	1500339	21	H24911	16903	1500411	24	H27411	24202	1500490	27
H22953	12930	1500262	21	H23305	13206	1500340	21	H24912	16904	1500412	24	H27412	24203	1500491	27
H22960	12912	1500263	21	H23306	13207	1500341	21	H24920	16906	1500413	24	H27413	24204	1500492	27
H22970	12922	1500264	21	H23307	13208	1500342	21	H24930	16905	1500414	24	H27414	24205	1500493	27
H22990	-	1501396	21	H23308	13209	1500343	21	H24960	16907	1500415	24	H27415	24206	1500494	27
H23100	13101	1500265	21	H23309	13210	1500344	21	H24980	-	1500416	24	H27416	24207	1500495	27
H23101	13102	1500280	21	H23310	13211	1500345	21	H25100	21501	1500417	25	H27417	24208	1500496	27
H23102	13103	1500267	21	H23311	13212	1500346	21	H25101	21502	1500418	25	H27418	24209	1500497	27
H23103	13104	1500268	21	H23312	13213	1500347	21	H25102	21503	1500419	25	H27420	25201	1500498	27
H23104	13105	1500269	21	H23313	13214	1500348	21	H25200	21301	1500420	25	H27421	25202	1500499	27
H23105	13106	1500270	21	H23400	13401	1500349	21	H25201	21302	1500421	25	H27422	25203	1500500	27
H23106	13107	1500271	21	H23401	13402	1500350	21	H25202	21303	1500422	25	H27423	25204	1500501	27
H23107	13108	1500272	21	H23402	13403	1500351	21	H25300	21101	1500423	25	H27424	25205	1500502	27
H23108	13109	1500273	21	H23403	13404	1500352	21	H25301	21102	1500424	25	H27425	25206	1500503	27
H23109	13110	1500274	21	H23404	13405	1500353	21	H25302	21103	1500425	25	H27426	25207	1500504	27
H23110	13111	1500275	21	H23405	13406	1500354	21	H25303	21104	1500426	25	H27427	25208	1500505	27
H23111	13112	1500276	21	H23406	13407	1500355	21	H25304	21105	1500427	25	H27428	25209	1500506	27
H23112	13113	1500277	21	H23407	13408	1500356	21	H25305	21106	1500428	25	H27433	-	1502033	27
H23113	13114	1500278	21	H23408	13409	1500357	21	H25306	21107	1500429	25	H27710	24801	1500507	27
H23114	13115	1500279	21	H23409	13410	1500358	21	H25307	-	1502029	25	H27711	24802	1500508	27
H23140	13501	1500280	21	H23410	13411	1500359	21	H25400	21201	1500430	26	H27712	24803	1500509	27
H23141	13502	1500281	21	H23411	13412	1500360	21	H25401	21202	1500431	26	H27713	24804	1500510	27
H23142	13503	1500282	21	H23412	13413	1500361	21	H25402	21203	1500432	26	H27714	24805	1500511	27
H23143	13504	1500283	21	H23413	13414	1500362	21	H25403	21204	1500433	26	H27715	24806	1500512	27
H23144	13505	1500284	21	H23414	13415	1500363	21	H25404	21205	1500434	26	H27716	24807	1500513	27
H23145	13506	1500285	21	H23415											

产品编号	货号	订货号	页码	产品编号	货号	订货号	页码	产品编号	货号	订货号	页码	产品编号	货号	订货号	页码
H35642	59343	1502245	50	H41102	92552	1502352	73	H48208	92207	1502409	105	H56001	70511	1502474	58
H35643	59344	1502246	50	H41103	92553	1502353	73	H48209	92209	1502410	105	H56002	70512	1502475	58
H35644	59345	1502247	50	H41104	92554	1502354	73	H49023	90623	1502411	103	H57001	70411	1502476	58
H35645	59346	1502248	50	H41105	92555	1502355	73	H49024	90624	1502412	103	H57002	70412	1502477	58
H35646	59347	1502249	50	H41111	92561	1502356	73	H49026	90626	1502413	103	H57003	70413	1502478	58
H35647	59348	1502250	50	H41112	92562	1502357	73	H49028	90628	1502414	103	H57004	70414	1501326	58
H35660	59351	1500786	50	H41113	92564	1502358	73	H49033	90633	1502415	103	H57005	-	1501327	58
H35661	59352	1500787	50	H41201	90751	1502359	73	H49034	90634	1502416	103	H58101	-	1502479	54
H35662	59353	1500788	50	H41202	90762	1502360	73	H49036	90636	1502417	103	H58102	-	1502480	54
H35663	59354	1500789	50	H41301	90771	1502361	73	H49038	90638	1502418	103	H58103	-	1502481	54
H35664	59355	1500790	50	H41302	90772	1502362	73	H50100	75101	1502419	83	H58104	-	1502482	54
H35665	59356	1500791	50	H41303	90753	1502363	73	H50101	75102	1502420	83	H58105	-	1502483	54
H35690	59271	1500792	51	H41304	90774	1502364	73	H50102	75103	1502421	83	H58106	-	1502484	54
H35691	59272	1500793	51	H41305	90775	1502365	73	H50103	75111	1502422	84	H58107	-	1502485	54
H35692	59273	1500794	51	H41306	90776	1502366	73	H50104	75121	1502423	84	H58108	-	1502486	54
H35710	59381	1500795	50	H41401	90752	1502367	73	H50105	75131	1502424	84	H58119	72011	1506407	55
H35711	59382	1500796	50	H41501	90755	1502368	73	H50106	75141	1502425	84	H58120	72012	1502408	55
H35712	59383	1500797	50	H41502	90782	1502369	73	H50107	75142	1502426	84	H58121	72013	1502409	55
H35713	59387	1500798	50	H41503	90783	1502370	73	H50200	91108	1502427	84	H58122	72014	1502410	55
H35714	59388	1500799	50	H41504	90784	1502371	73	H50201	91201	1502428	84	H58123	72021	1502411	55
H35720	59384	1500800	50	H41505	90785	1502372	73	H50202	91202	1502429	84	H58124	72022	1502412	55
H35721	59385	1500801	50	H41506	90786	1502373	73	H50203	91212	1502430	84	H58125	72023	1502413	55
H35722	59386	1500802	50	H41601	90754	1502374	73	H50204	91213	1502431	84	H58126	72024	1502414	55
H35730	59391	1500803	50	H41800	90800	1502375	73	H50301	72501	1501431	84	H58150	72001	1502487	54
H35731	59392	1500804	50	H41801	90801	1502376	73	H50302	72502	1501432	84	H58151	72002	1502488	54
H35732	59393	1500805	50	H41802	90802	1502377	73	H50303	72503	1501433	84	H58152	-	1506423	55
H35810	59411	1500806	50	H41803	90803	1502378	73	H50701	70641	1502447	84	H58153	-	1506424	55
H35811	59413	1500807	50	H41804	90804	1502379	73	H50702	70642	1502448	84	H58219	72031	1506415	55
H35812	59415	1500808	50	H41805	90805	1502380	73	H50703	70643	1502449	84	H58220	72032	1506416	55
H35813	59416	1500809	50	H41806	90806	1502381	73	H51101	70331	1500846	53	H58221	72033	1506417	55
H35814	59417	1500810	50	H41807	90807	1502382	73	H51102	70332	1502450	53	H58222	72034	1506417	55
H35820	59421	1500811	50	H41808	90808	1502383	73	H51103	70333	1500847	53	H58223	72041	1506419	55
H35821	59422	1500812	50	H41809	90809	1502384	73	H51201	70131	1500850	53	H58224	72042	1506420	55
H35822	59423	1500813	50	H42100	92311	1500823	75	H51202	70132	1500851	53	H58225	72043	1506421	55
H35823	59424	1500814	50	H42101	92312	1500824	75	H51301	70232	1500854	53	H58226	72044	1506422	55
H35840	59453	1502251	50	H42102	92313	1500825	75	H51302	70233	1502451	53	H58250	-	1502497	54
H35841	59454	1502252	50	H42103	92314	1500826	75	H51401	70141	1502452	53	H58251	-	1502498	54
H35842	59456	1502253	50	H42200	92302	1500827	74	H51511	72635	1502453	53	H58252	72004	1506425	55
H35843	59457	1502254	50	H42201	92303	1500828	74	H53100	70301A	1500856	54	H58253	72005	1506426	55
H35844	59458	1502255	50	H42202	92304	1500829	74	H53101	70302A	1500857	54	H59100	71101	1500870	59
H35845	59459	1501424	50	H43100	92401	1500830	75	H53102	70303A	1500858	54	H59101	71102	1500871	59
H35860	59471	1500815	51	H43101	92402	1500831	75	H53110	-	1503925	57	H59102	71103	1500872	59
H35861	59472	1500816	51	H43102	92403	1500832	75	H53111	-	1503926	57	H59200	71202	1500873	59
H35862	59473	1500817	51	H43103	92404	1500833	75	H53112	-	1503927	57	H59201	71203	1500874	59
H35863	59478	1500818	51	H43104	92405	1500834	75	H53160	-	1502454	55	H59300	71301	1500875	59
H35864	59474	1500819	51	H43105	92406	1500835	75	H53161	-	1502455	55	H59301	71302	1500876	59
H35865	59475	1500820	51	H44100	92321	1500836	75	H53162	-	1502456	55	H59400	71401	1500877	59
H35866	59476	1500821	51	H44101	92322	1500837	75	H53200	70101A	1500859	54	H59401	71501	1500878	59
H35870	59464	1502256	51	H44102	92323	1500838	75	H53201	70102A	1500860	54	H59402	71601	1500879	59
H35871	59465	1502257	51	H44104	92325	1500839	75	H53210	-	1503928	57	H59403	71701	1500880	59
H35872	59467	1502258	51	H44200	92306	1500840	74	H53211	-	1503929	57	H60001	90433	1502509	58
H35873	59468	1502259	51	H44201	92307	1500841	74	H53260	-	1502457	55	H60002	90434	1502510	58
H35874	59469	1501425	51	H44300	-	1502385	74	H53261	-	1502458	55	H60003	90435	1502511	58
H35910	59515	1502260	51	H45100	92501	1500842	75	H53300	70201A	1500861	54	H60004	90436	1502512	58
H35920	59522	1502261	51	H45101	92502	1500843	75	H53301	70202A	1500862	54	H61000	93109	1500881	85
H35930	59533	1502262	51	H45102	92503	1500844	75	H53302	70203A	1500863	54	H61001	93110	1502513	85
H35931	59534	1502263	51	H45103	92504	1502386	75	H53361	-	1502460	55	H61010	93470	1502514	85
H35932	59535	1502264	51	H45104	92505	1500845	75	H53362	-	1502461	55	H61011	93471	1502515	85
H35933	59536	1502265	51	H46000	92901	1502387	75	H53401	72201	1501374	57	H61012	93472	1502516	85
H35934	59537	1501426	51	H46001	92902	1502388	75	H53402	72202	1501375	57	H61100	93501	1500882	61
H35935	59538	1502266	51	H46002	92903	1502389	75	H53403	72203	1501376	57	H61101	93502	1500883	61
H35936	59539	1501427	51	H46003	92904	1502390	75	H53310	-	1503930	55	H61102	93503	1500884	61
H35937	59540	1502267	51	H47001	92521	1502391	75	H53311	-	1503931	55	H61103	93504	1500885	61
H35960	59571	1501428	51	H47002	92522	1502392	75	H53312	-	1503932	55	H61104	93505	1500886	61
H35961	59572	1501429	51	H47003	92523	1502393	75	H53501	72401	1501390	57	H61105	93506	1500887	61
H35962	59573	1502268	51	H47004	92524	1502394	75	H53502	72402	1501377	57	H61106	93507	1500888	61
H35963	59574	1502269	51	H47005	92525	1502395	75	H53601	72301	1501378	57	H61107	93508	1500889	61
H35964	59575	1502270	51	H47011	92531	1502396	75	H53602	72302	1501379	57	H61108	93509	1500890	61
H35965	59576	1502271	51	H47012	92532	1502397	75	H54100	70611A	1500864	57	H61121	93502B	1502517	61
H35966	59577	1502272	50	H47013	92533	1502398	75	H54150	-	1502463	56	H61122	93503B	1502518	61
H35967	59578	1502273	50	H47014	92534	1502399	75	H54200	70612A	1500865	55	H61123	93504B	1502519	61
H35970	59562	1502274	50	H47015	92535	1502400	75	H54250	-	1502464	56	H61124	93505B	1502520	61
H35971	59563	1502275	50	H48200	92101	1502401	105	H54300	70615A	1500866	55	H61125	93506B	1502521	61
H35972	59564	1502276	50	H48201	92102	1502402	105	H54350	-	1502465	56	H61126	93507B	1502522	61
H35973	59565	1502277	50	H48202	92103	1502403	105	H54400	70613A	1500867	55	H61127	93508B	1502523	61
H35974	59566	1501430	50	H48203	92104	1502404	105	H54450	-	1502466	56	H61201	93101	1502524	61
H36000	61002	1500822	51	H48204	92105	1502405	105	H54500	70614A	1500868	57				